

Part number

MAV 06 LG32



Hood, C-TYPE series, with 1 lever, M32 top cable entry, size "44.27", high construction

Product description

Product type	Hood
Series	C-TYPE
Closing type	With 1 lever
Size	Size 44.27
Cable entry	Top cable entry with adapter M32
Specification	High construction

Technical data

IP degree of protection IP65 / IP66 / IP69

Further technical details

Weight	241,00 g
Operating temperature range (min, max)	-40°C...+125°C

Material properties

Other materials	Lever: Stainless steel, polyamide (PA) Gasket: NBR
Colour	RAL 7040 grey
RoHs conformity	Compliant with exemption 6(c): copper alloy containing up to 4% lead by weight
China RoHs - EFUP	50
REACH SVHC substances	Yes Lead
SCIP number	15deaf78-e939-4401-a0b0-e2228ca32a03

Approvals / Standards

Certifications	DNV, BV
UL	ECBT2
cUL	ECBT8

General ordering information

EAN13 code	8015747052139
eCl@ss 8.1	27440202
ETIM 7.0	EC000437

Packaging Information

Packaging length	160,00 mm
Packaging height	130,00 mm
Packaging width	270,00 mm
Packaging weight	2,41 kg
Packaging description	Carton box
Packaging quantity	10 Pcs
Packaging EAN code	8015747303088
Sub-packaging weight	1,21 kg
Sub-packaging description	Plastic packaging
Sub-packaging quantity	5 Pcs
Sub-packaging EAN barcode	8015747052146

Part number

MAV 06 LG32



Catalogue drawings

CHO LX CHV LX - MHO LX MHV LX



CHV LG (CAV LG), MHV LG (MAV LG) [MFV LG]

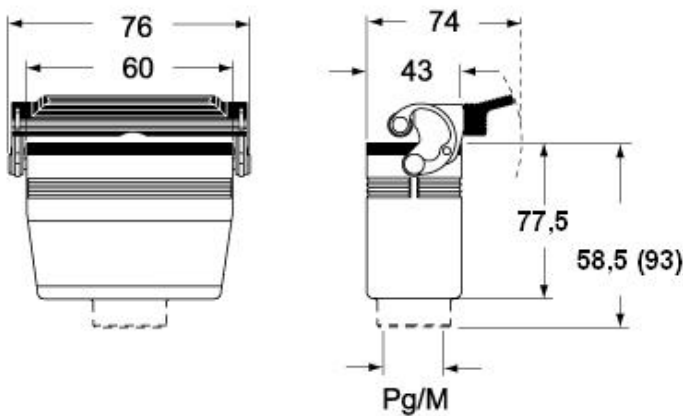

CHO L (CAO L) - MHO (MAO/MFO/MFV L) MHV L [MAV L]

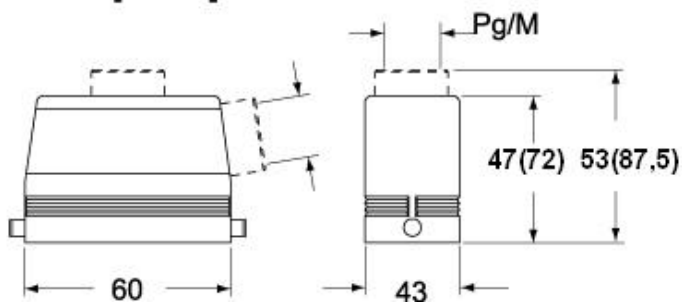

Notes