

Part number

KI 6363 RI5



Interlocked switched socket-outlet, KI series, 2 poles + PE, 6 h (blue), 63 A, 200 ÷ 250 V, with compartment for modular units, 7 DIN-rail modules EN 60715

Product description

Product type	Interlocked switched socket-outlet
Series	KI..RI5
N. of poles	2 poles + 
Clock position	6
Size	143x343 fixing plates FC xx53 TB
Cable entry	Pg29
Specification	With compartment for modular units, 7 DIN-rail modules EN 60715

Technical data

Current	63 A
Voltage	200 ÷ 250 V
IP degree of protection	IP55

Further technical details

Weight	2.237,00 g
Operating temperature range (min, max)	-25°C ... +40°C
IK rating (impact degree of protection)	IK10

Material properties

Colour	RAL 7035 grey, RAL 5015 blue
RoHs conformity	Compliant with exemption 6(c): copper alloy containing up to 4% lead by weight
China RoHs - EFUP	50
REACH SVHC substances	Yes Lead
SCIP number	F6799547-ab84-42f2-938f-233ba663766d

Approvals / Standards

Reference standard	EN 60309-1, -2 e -4
---------------------------	---------------------

General ordering information

EAN13 code	8015747049580
-------------------	---------------

Packaging Information

Packaging length	400,00 mm
Packaging height	165,00 mm
Packaging width	170,00 mm
Packaging weight	2,49 kg
Packaging volume	11,22 dm ³
Packaging description	Carton box
Packaging quantity	1 Pcs
Packaging EAN code	8015747049597

Part number

KI 6363 RI5



Catalogue drawings

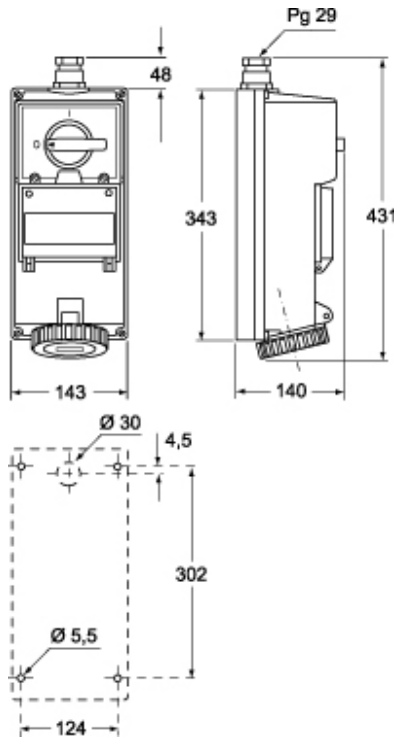

Notes