

Part number

# KI 3273 RI5



Interlocked switched socket-outlet, KI series, 2 poles + PE, 7 h (black), 32 A, 480 ÷ 500 V, with compartment for modular units, 7 DIN-rail modules EN 60715

#### Product description

<b>Product type</b>	Interlocked switched socket-outlet
<b>Series</b>	KI..RI5
<b>N. of poles</b>	2 poles + 
<b>Clock position</b>	7
<b>Cable entry</b>	Pg29
<b>Specification</b>	With compartment for modular units, 7 DIN-rail modules EN 60715

#### Technical data

<b>Current</b>	32 A
<b>Voltage</b>	480 ÷ 500 V
<b>IP degree of protection</b>	IP55

#### Further technical details

<b>Operating temperature range (min, max)</b>	-25°C ... +40°C
<b>IK rating (impact degree of protection)</b>	IK10

#### Material properties

<b>Colour</b>	RAL 7035 grey, RAL 9005 black
---------------	-------------------------------

#### Approvals / Standards

<b>Reference standard</b>	EN 60309-1, -2 e -4
---------------------------	---------------------

#### General ordering information

<b>EAN13 code</b>	8015747151337
-------------------	---------------

Part number

# KI 3273 RI5



## Catalogue drawings

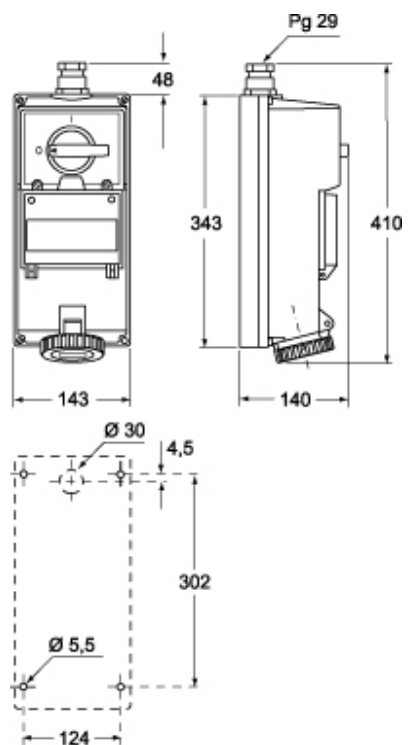

---

Notes