

Part number

KI 3244 RI5



Interlocked switched socket-outlet, KI series, 3 poles + PE, 4 h (yellow), 32 A, 100 ÷ 130 V, with compartment for modular units, 7 DIN-rail modules EN 60715

Product description		Material properties	
Product type	Interlocked switched socket-outlet	Colour	RAL 7035 grey, RAL 1021 yellow
Series	KI..RI5		Compliant with exemption 6(c): copper alloy containing up to 4% lead by weight
N. of poles	3 poles + 	RoHs conformity	6(c): copper alloy containing up to 4% lead by weight
Clock position	4	China RoHs - EFUP	50
Size	143x343 fixing plates FC xx53 TB	REACH SVHC substances	Yes Lead
Cable entry	Pg29	SCIP number	F6799547-ab84-42f2-938f-233ba663766d
Specification	With compartment for modular units, 7 DIN-rail modules EN 60715	Approvals / Standards	
Technical data		Reference standard	EN 60309-1, -2 e -4
Current	32 A	General ordering information	
Voltage	100 ÷ 130 V	EAN13 code	8015747049108
IP degree of protection	IP55	Packaging Information	
Further technical details		Packaging length	400,00 mm
Weight	1.800,00 g	Packaging height	165,00 mm
Operating temperature range (min, max)	-25°C ... +40°C	Packaging width	170,00 mm
IK rating (impact degree of protection)	IK10	Packaging weight	1,80 kg
		Packaging volume	11,22 dm ³
		Packaging description	Carton box
		Packaging quantity	1 Pcs
		Packaging EAN code	8015747049115

Part number

KI 3244 RI5



Catalogue drawings

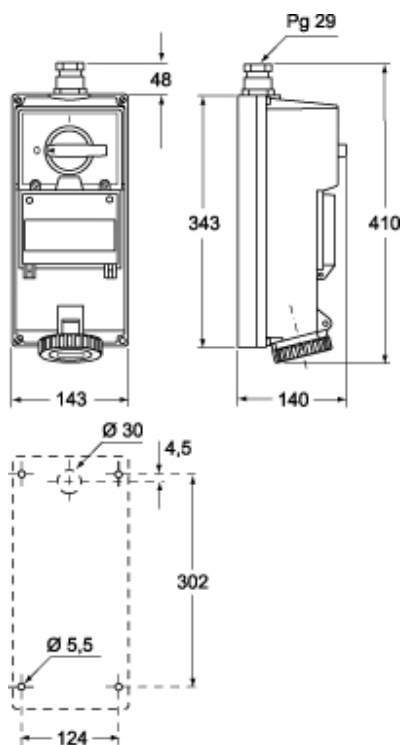

Notes