

Part number

KI 3223 RI5



Interlocked switched socket-outlet, KI series, 2 poles + PE, 2 h (green), 32 A, > 50 V, with compartment for modular units, 7 DIN-rail modules EN 60715

Product description

Product type	Interlocked switched socket-outlet
Series	KI..RI5
N. of poles	2 poles + 
Clock position	2
Cable entry	Pg29
Specification	With compartment for modular units, 7 DIN-rail modules EN 60715

Technical data

Current	32 A
Voltage	> 50 V
IP degree of protection	IP55

Further technical details

Operating temperature range (min, max)	-25°C ... +40°C
IK rating (impact degree of protection)	IK10

Material properties

Colour	RAL 7035 grey, RAL 6017 green
---------------	-------------------------------

Approvals / Standards

Reference standard	EN 60309-1, -2 e -4
---------------------------	---------------------

General ordering information

EAN13 code	8015747151153
-------------------	---------------

Part number

KI 3223 RI5



Catalogue drawings

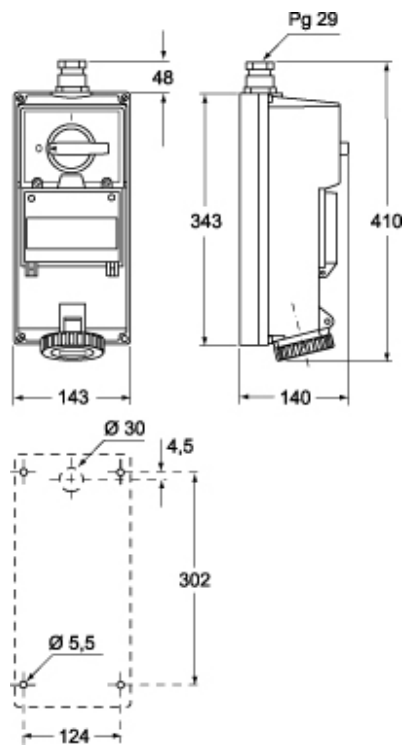

Notes