

Part number

KI 16115 RI5



Interlocked switched socket-outlet, KI series, 3 poles + N + PE, 11 h (red), 16 A, 250/440 ÷ 265/460 V, with compartment for modular units, 7 DIN-rail modules EN 60715

Product description

Product type	Interlocked switched socket-outlet
Series	KI..RI5
N. of poles	3 poles + N + 
Clock position	11
Cable entry	Pg29
Specification	With compartment for modular units, 7 DIN-rail modules EN 60715

Technical data

Current	16 A
Voltage	250/440V ÷ 265/460V
IP degree of protection	IP55

Further technical details

Operating temperature range (min, max)	-25°C ... +40°C
IK rating (impact degree of protection)	IK10

Material properties

Colour	RAL 7035 grey, RAL 3000 red
---------------	-----------------------------

Approvals / Standards

Reference standard	EN 60309-1, -2 e -4
---------------------------	---------------------

General ordering information

EAN13 code	8015747150743
-------------------	---------------

Part number

KI 16115 RI5



Catalogue drawings

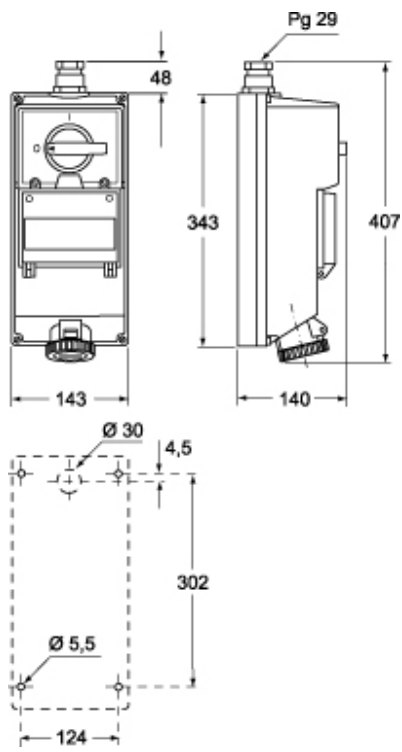

Notes