

Part number

FC 1453 TB



Modular back plate for socket outlets set mounting, FC series

Product description	
Product type	Modular back plate for socket outlets set mounting
Series	FC
Size	143x343 fixing plates FC xx53 TB
Further technical details	
Weight	436,00 g
Operating temperature range (min, max)	-40°C ... +125°C

Material properties	
Colour	RAL 7035 grey
General ordering information	
EAN13 code	8015747045544
Packaging Information	
Packaging length	310,00 mm
Packaging height	170,00 mm
Packaging width	550,00 mm
Packaging weight	5,40 kg
Packaging volume	28,99 dm ³
Packaging description	Carton box
Packaging quantity	10 Pcs
Packaging EAN code	8015747045551

Part number

FC 1453 TB



Catalogue drawings

FC 1141 TB

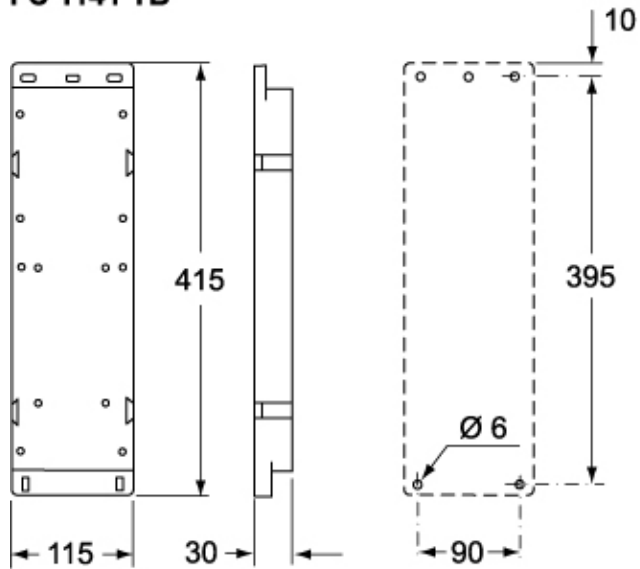

FC 1453 TB

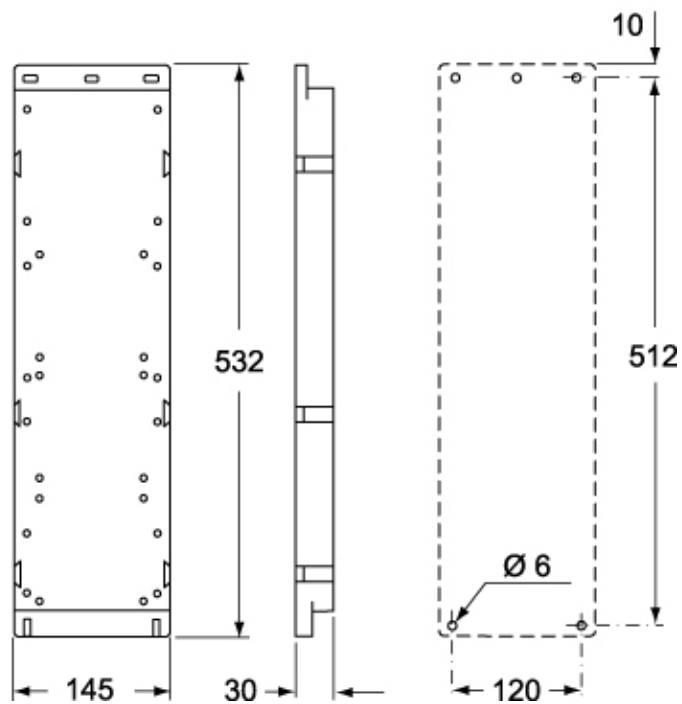

Notes