

Part number

CZAVT 25.4 L



Hood, IL-BRID series, with 2 pegs, 1/2" NPT top cable entry, size "66.16", high construction

Product description		Material properties	
Product type	Hood	Other materials	Gasket: NBR
Series	IL-BRID	Colour	RAL 7040 grey
Closing type	With 2 pegs		Compliant with exemption 6(c): copper alloy containing up to 4% lead by weight
Size	Size 66.16	RoHs conformity	
Cable entry	Top cable entry with adapter 1/2" NPT	China RoHs - EFUP	50
Specification	High construction	REACH SVHC substances	Yes Lead
Technical data		SCIP number	15deaf78-e939-4401-a0b0-e2228ca32a03
IP degree of protection	IP65 / IP66 / IP69	Approvals / Standards	
Further technical details		UL	ECBT2
Weight	197,00 g	cUL	ECBT8
Operating temperature range (min, max)	-40°C...+125°C	General ordering information	
		EAN13 code	8015747043670
		Packaging Information	
		Sub-packaging length	260,00 mm
		Sub-packaging height	115,00 mm
		Sub-packaging width	120,00 mm
		Sub-packaging weight	1,97 kg
		Sub-packaging volume	3,59 dm ³
		Sub-packaging description	Carton box
		Sub-packaging quantity	10 Pcs
		Sub-packaging EAN barcode	8015747043687

Part number

CZAVT 25.4 L



Catalogue drawings

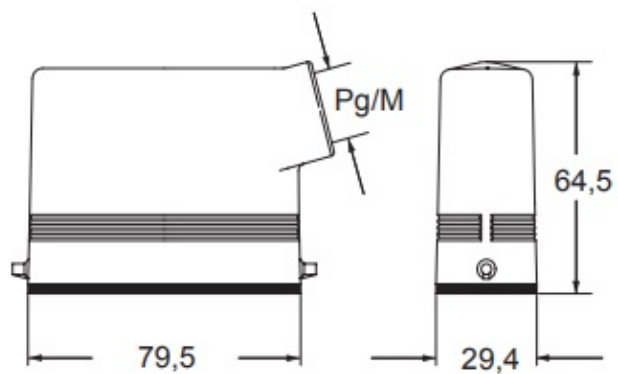

Notes