

Part number

CZAV 25 L21



Hood, IL-BRID series, with 2 pegs, Pg21 top cable entry, size "66.16", high construction

Product description		Material properties	
Product type	Hood	Other materials	Gasket: NBR
Series	IL-BRID	Colour	RAL 7040 grey
Closing type	With 2 pegs		Compliant with exemption 6(c): copper alloy containing up to 4% lead by weight
Size	Size 66.16	RoHs conformity	
Cable entry	Top cable entry with adapter Pg21	China RoHs - EFUP	50
Specification	High construction	REACH SVHC substances	Yes Lead
Technical data		SCIP number	15deaf78-e939-4401-a0b0-e2228ca32a03
IP degree of protection	IP66 / IP67 / IP69	Approvals / Standards	
Further technical details		UL	ECBT2
Weight	173,00 g	cUL	ECBT8
Operating temperature range (min, max)	-40°C...+125°C	General ordering information	
		EAN13 code	8015747043618
		Packaging Information	
		Packaging length	225,00 mm
		Packaging height	130,00 mm
		Packaging width	150,00 mm
		Packaging weight	1,85 kg
		Packaging volume	4,39 dm ³
		Packaging description	Carton box
		Packaging quantity	10 Pcs
		Packaging EAN code	8015747220729
		Sub-packaging weight	0,93 kg
		Sub-packaging description	Plastic packaging
		Sub-packaging quantity	5 Pcs
		Sub-packaging EAN barcode	8015747220736

Part number

CZAV 25 L21



Catalogue drawings

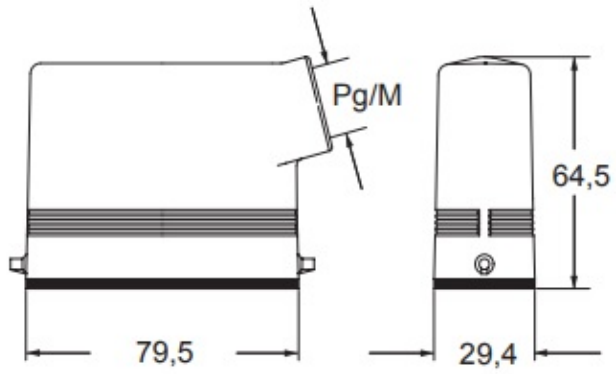

Notes