

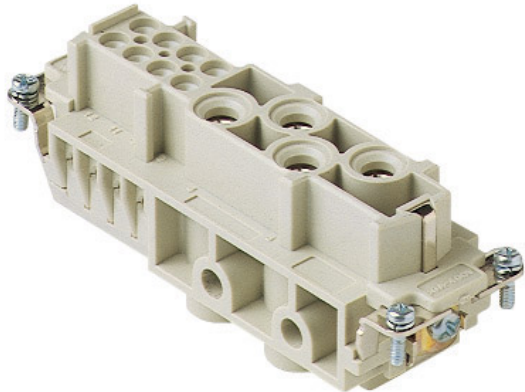

Part number

CXF 4/8



Female insert, CX series, screw terminal connection, 4 + 8 poles + PE, 80 A 400 V 6 kV 3 / 16 A 230/400 V 4 kV 3, size "104.27"

Product description

Product type	Insert
Series	CX
Connection type	Screw terminal connection
Gender	Female
N. of poles	4 poles + 
Auxiliary poles	8 poles
Size	Size 104.27

Technical data

Current	80 A
Voltage	400 V
Rated impulse withstand voltage	6 kV
Pollution degree	3
Rated voltage according to UL/CSA	600 V
Wire cross-section	4,00 mm ² - 16,00 mm ²
AWG size	12 - 6
Contact type	Turned silver plated
IP degree of protection	IP20 without enclosure, IP65/IP66/IP68/IP69 with enclosure

Further technical details

Characteristics according to EN 61984	80A 400V 6kV 3 (aux:16A 230/400V 4kV 3); 80A 400/690V 6kV 2 (aux:16A 400V 4kV 2)
Mating cycles	≥ 500
Insulation resistance	≥ 10 GΩ
Weight	150,00 g
Operating temperature range (min, max)	-40 °C ... +125 °C
UL 94 flammability rating	V-0

Material properties

Main material	Polycarbonate (PC)
Other materials	Contacts: copper alloy
Colour	RAL 7032 grey
RoHs conformity	Compliant with exemption 6(c): copper alloy containing up to 4% lead by weight
China RoHs - EFUP	50
REACH SVHC substances	Yes Lead
SCIP number	1a9c93ff-0445-4a16-81e3-1609ac5274d6

Approvals / Standards

Reference standard	EN 61984:2009-06
Certifications	CSA, CQC, DNV, BV, EAC
UL	ECBT2
cUL	ECBT8

General ordering information

EAN13 code	8015747042352
eCl@ss 8.1	27440205
ETIM 7.0	EC000438

Packaging Information

Packaging length	245,00 mm
Packaging height	165,00 mm
Packaging width	215,00 mm
Packaging weight	4,89 kg
Packaging volume	8,69 dm ³
Packaging description	Carton box
Packaging quantity	30 Pcs
Packaging EAN code	8015747191852
Sub-packaging length	113,00 mm
Sub-packaging height	36,00 mm
Sub-packaging width	180,00 mm
Sub-packaging weight	0,82 kg
Sub-packaging volume	0,73 dm ³
Sub-packaging description	Carton tray
Sub-packaging quantity	5 Pcs
Sub-packaging EAN barcode	8015747042369

Part number

CXF 4/8



Catalogue drawings

CXM 4/8

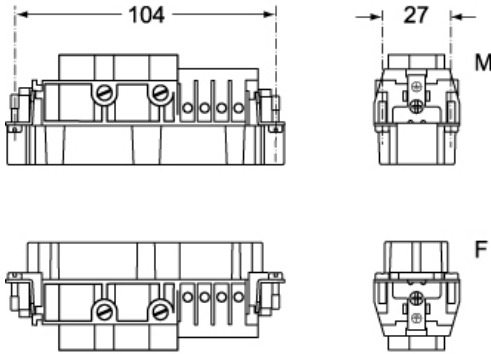

Catalogue drawings

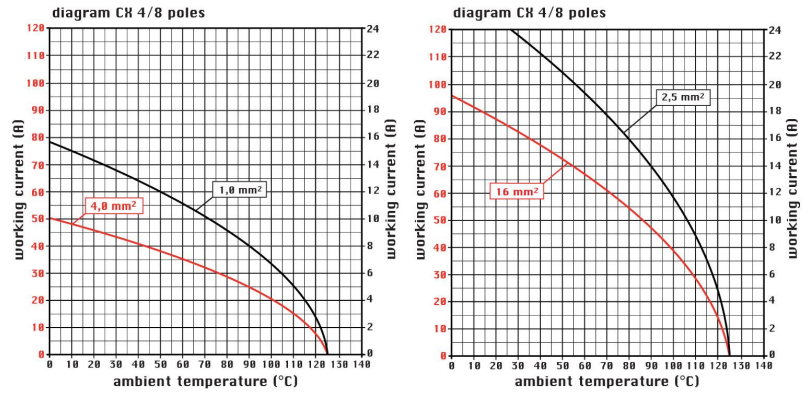

CXF 4/8

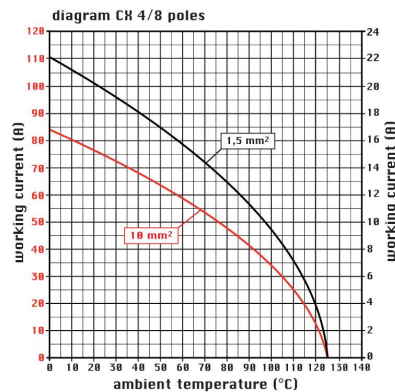
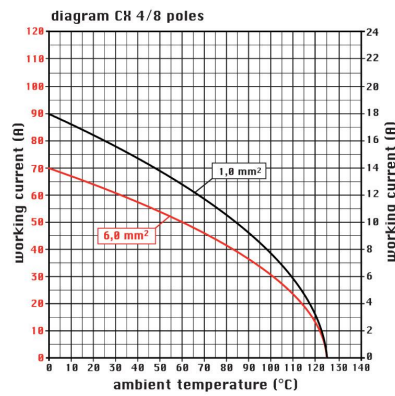
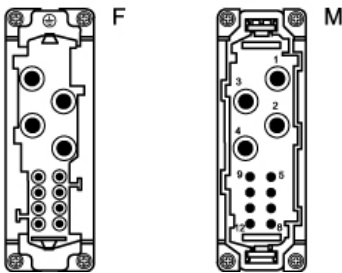

Notes

California Proposition 65 Information



WARNING

This product can expose you to lead and its compounds, known to the State of California to cause cancer and/or reproductive toxicity. For more information go to www.P65Warnings.ca.gov.
