

Part number

CX7MA 25

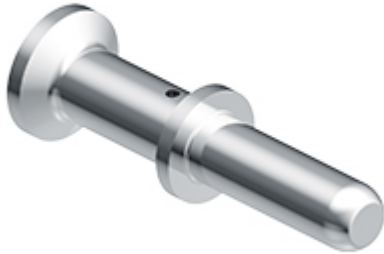

Male crimp contact, CX7 series, 70 A, turned silver plated, wire cross section 25 mm², AWG 4 - 3

Product description		Material properties	
Product type	Crimp contact	Main material	Copper alloy
Series	CX7		Compliant with exemption 6(c): copper alloy containing up to 4% lead by weight
Gender	Male	RoHs conformity	6(c): copper alloy containing up to 4% lead by weight
Technical data		China RoHs - EFUP	50
Current	70 A	REACH SVHC substances	Yes
Wire cross-section	25,00 mm ²		Lead
AWG size	4 - 3	SCIP number	C0979fba-9907-458f-a94a-db781440f273
Contact type	Turned silver plated	Approvals / Standards	
Further technical details		Certifications	CSA, EAC
Mating cycles	≥ 500	UL	ECBT2
Contact resistance	≤ 0,5 mΩ	cUL	ECBT8
Weight	10,80 g	General ordering information	
Operating temperature range (min, max)	-40°C ... +125°C	EAN13 code	8015747182485
Conductors stripping length	15 mm	eCl@ss 8.1	27440204
		ETIM 7.0	EC000796
		Packaging Information	
		Sub-packaging length	50,00 mm
		Sub-packaging height	44,00 mm
		Sub-packaging width	50,00 mm
		Sub-packaging weight	0,17 kg
		Sub-packaging volume	0,11 dm ³
		Sub-packaging description	Plastic box
		Sub-packaging quantity	16 Pcs
		Sub-packaging EAN barcode	8015747182546

Part number

CX7MA 25



Catalogue drawings

PART NUMBERS SILVER PLATED	øA mm	B mm	WIRE GAUGE		STRIPPING LENGTH mm
			mm ²	AWG	
CX7MA 6.0	3,5	36	6	10	15
CX7MA 10	4,3	35,2	10	7	
CX7MA 16	5,5	35,2	16	5	
CX7MA 16 XF	6,1	35,2	16	3	
CX7MA 25	7,0	35,2	25	3	

Catalogue drawings

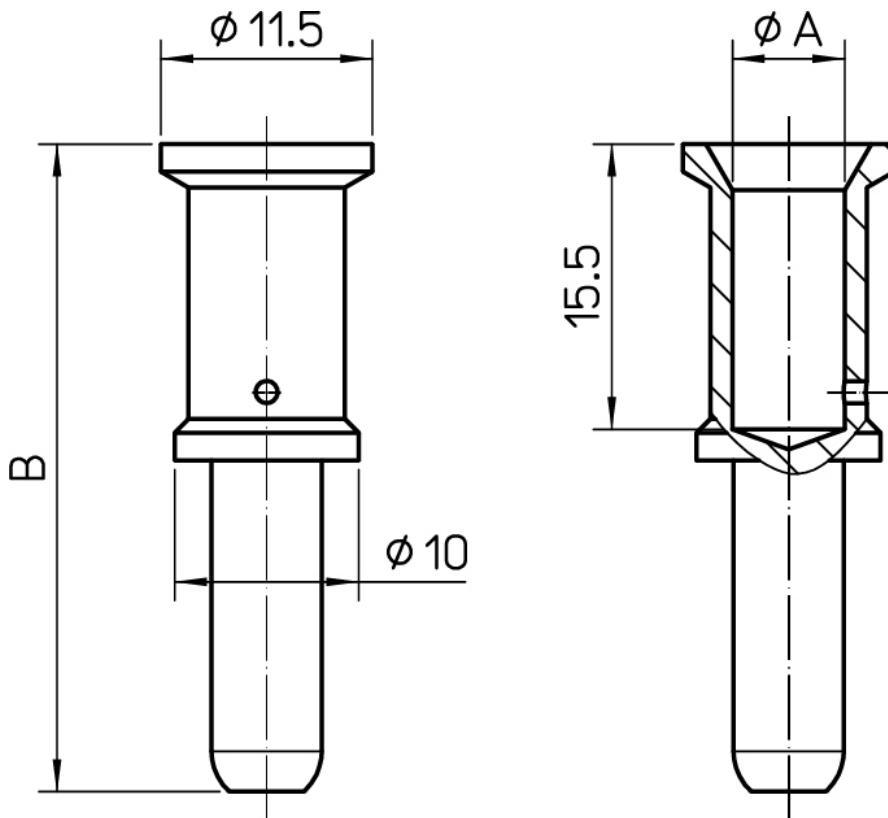

Notes

California Proposition 65 Information



WARNING

This product can expose you to lead and its compounds, known to the State of California to cause cancer and/or reproductive toxicity. For more information go to www.P65Warnings.ca.gov.
