

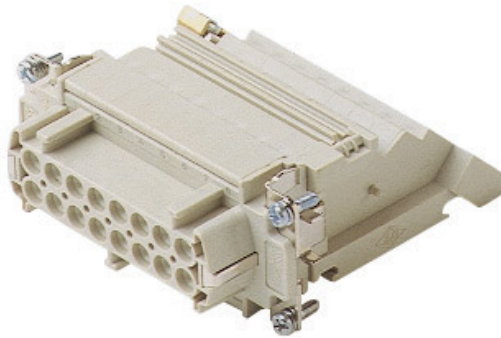

Part number

CTSEF 16 L



Female insert, CTSE series, spring terminal connection, 16 poles + PE, 16 A 500 V 6 kV 3, size "77.27", with incorporated terminal block, left side mounting

Product description

Product type	Insert
Series	CTSE
Connection type	Spring terminal connection
Gender	Female
N. of poles	16 poles + 
Size	Size 77.27
Specification	Left side mounting With incorporated terminal block

Technical data

Current	16 A
Voltage	500 V
Rated impulse withstand voltage	6 kV
Pollution degree	3
Rated voltage according to UL/CSA	600 V
Wire cross-section	0,14 mm ² - 2,50 mm ²
AWG size	26 - 14
Contact type	Turned silver plated
IP degree of protection	IP20 without enclosure, IP66/IP69 with enclosure

Further technical details

Characteristics according to EN 61984	16A 500V 6kV 3; 16A 400/690V 6kV 2
Mating cycles	≥ 500
Insulation resistance	≥ 10 GΩ
Contact resistance	≤ 4 mΩ
Weight	150,00 g
Operating temperature range (min, max)	-40 °C ... +125 °C
Conductors stripping length	9...11 mm
UL 94 flammability rating	V-0

Material properties

Main material	Polycarbonate (PC)
Other materials	Contacts: copper alloy
Colour	RAL 7032 grey
RoHs conformity	Compliant with exemption 6(c): copper alloy containing up to 4% lead by weight
China RoHs - EFUP	50
REACH SVHC substances	Yes Lead
SCIP number	1a9c93ff-0445-4a16-81e3-1609ac5274d6

Approvals / Standards

Reference standard	EN 61984:2009-06
Certifications	CSAc, CQC, DNV, BV, EAC
UL	ECBT2

General ordering information

EAN13 code	8015747122351
eCl@ss 8.1	27440205
ETIM 7.0	EC000438

Packaging Information

Packaging weight	0,64 kg
Packaging description	Carton box
Packaging quantity	4 Pcs
Packaging EAN code	8015747123594
Sub-packaging length	145,00 mm
Sub-packaging height	89,00 mm
Sub-packaging width	90,00 mm
Sub-packaging weight	0,16 kg
Sub-packaging volume	1,16 dm ³
Sub-packaging description	Plastic packaging
Sub-packaging quantity	1 Pcs
Sub-packaging EAN barcode	8015747123600

Part number

CTSEF 16 L



Catalogue drawings

Catalogue drawings

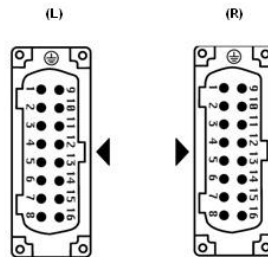
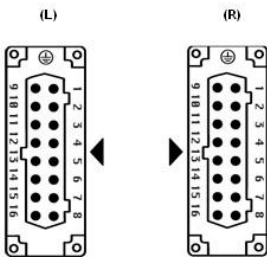
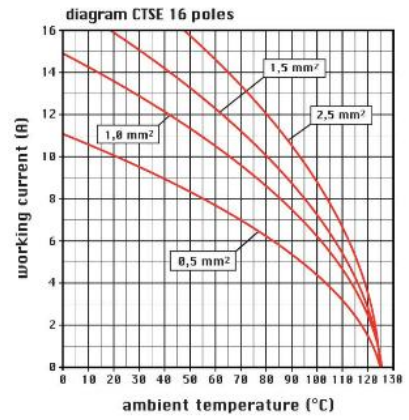
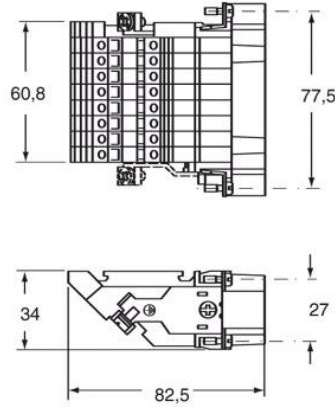
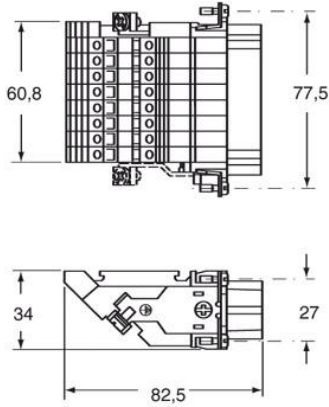

Notes

California Proposition 65 Information



WARNING

This product can expose you to lead and its compounds, known to the State of California to cause cancer and/or reproductive toxicity. For more information go to www.P65Warnings.ca.gov.

California Proposition 65 Information



WARNING

This product can expose you to lead and its compounds, known to the State of California to cause cancer and/or reproductive toxicity. For more information go to www.P65Warnings.ca.gov.