

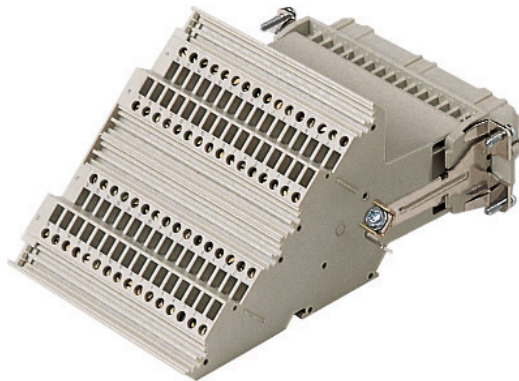

Part number

CTF 64 L



Female insert, CT series, screw terminal connection, 64 poles + PE, 10 A 250 V 4 kV 3, size "104.27", with incorporated terminal block, left side mounting

Product description

Product type	Insert
Series	CT
Connection type	Screw terminal connection
Gender	Female
N. of poles	64 poles + 
Size	Size 104.27
Specification	Left side mounting With incorporated terminal block

Technical data

Current	10 A
Voltage	250 V
Rated impulse withstand voltage	4 kV
Pollution degree	3
Rated voltage according to UL/CSA	600 V
Wire cross-section	0,75 mm ² - 2,50 mm ²
AWG size	18 - 14
Contact type	Turned silver plated
IP degree of protection	IP20 without enclosure, IP66/IP69 with enclosure

Further technical details

Characteristics according to EN 61984	10A 250V 4kV 3; 10A 230/400V 4kV 2
Mating cycles	≥ 500
Insulation resistance	≥ 10 GΩ
Contact resistance	≤ 4 mΩ
Weight	558,00 g
Operating temperature range (min, max)	-40 °C ... +125 °C
Conductors stripping length	12 mm
UL 94 flammability rating	V-0
Torque for main contact	M2,6: 0,4 Nm; 3,5 lb.in (0,5 x 3 mm)
Tightening torque for PE connection	M4: 1,2 Nm, 10,6 lb.in (Ph2 or 1,0x5,5mm)
Tightening torque for fixing screws	M3: 0.5 Nm; 4.4 lb.in (Ph1 or 0.8x4 mm)

Material properties

Main material	Polycarbonate (PC)
Other materials	Contacts: copper alloy
Colour	RAL 7032 grey
RoHs conformity	Compliant with exemption 6(c): copper alloy containing up to 4% lead by weight
China RoHs - EFUP	50
REACH SVHC substances	Yes Lead
SCIP number	1a9c93ff-0445-4a16-81e3-1609ac5274d6

Approvals / Standards

Reference standard	EN 61984:2009-06
Certifications	CSA, CQC, DNV, BV, EAC
UL	ECBT2

General ordering information

EAN13 code	8015747041003
eCl@ss 8.1	27440205
ETIM 7.0	EC000438

Packaging Information

Sub-packaging length	145,00 mm
Sub-packaging height	89,00 mm
Sub-packaging width	120,00 mm
Sub-packaging weight	0,56 kg
Sub-packaging volume	1,55 dm ³
Sub-packaging description	Carton box
Sub-packaging quantity	1 Pcs
Sub-packaging EAN barcode	8015747041010

Part number

CTF 64 L



Catalogue drawings

Catalogue drawings

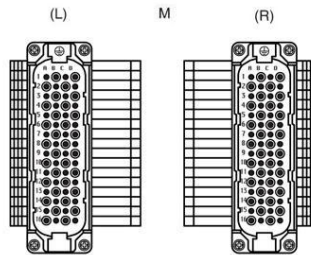
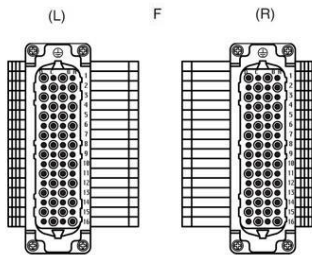
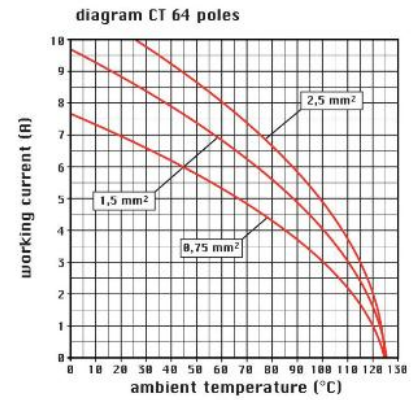
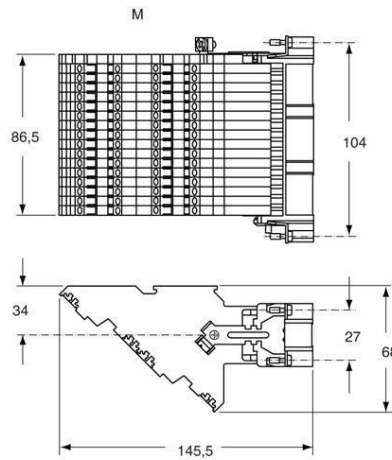
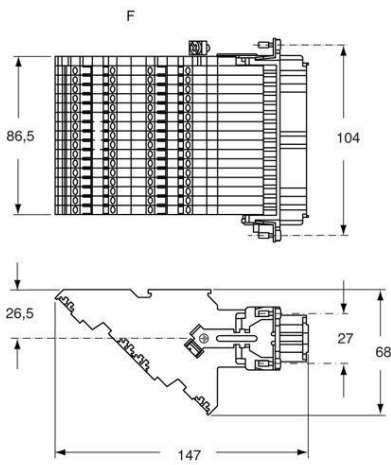

Notes

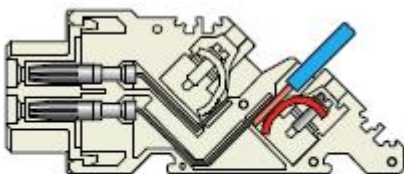

California Proposition 65 Information



WARNING

This product can expose you to lead and its compounds, known to the State of California to cause cancer and/or reproductive toxicity. For more information go to www.P65Warnings.ca.gov.

California Proposition 65 Information



WARNING

This product can expose you to lead and its compounds, known to the State of California to cause cancer and/or reproductive toxicity. For more information go to www.P65Warnings.ca.gov.
