

Part number

CSSF 16



Female insert, CSS series, dual spring terminal connection, 16 poles + PE, 16 A 500 V 6 kV 3, size "77.27"

Product description

Product type	Insert
Series	CSS
Connection type	Dual spring terminal connection
Gender	Female
N. of poles	16 poles +
Size	Size 77.27

Technical data

Current	16 A
Voltage	500 V
Rated impulse withstand voltage	6 kV
Pollution degree	3
Rated voltage according to UL/CSA	600 V
Wire cross-section	0,14 mm ² - 2,50 mm ²
AWG size	26 - 14
Contact type	Turned silver plated
IP degree of protection	IP20 without enclosure, IP65/IP66/IP68/IP69 with enclosure

Further technical details

Characteristics according to EN 61984	16A 500V 6kV 3; 16A 400/690V 6kV 2
Mating cycles	≥ 500
Insulation resistance	≥ 10 GΩ
Contact resistance	≤ 3 mΩ
Weight	125,00 g
Operating temperature range (min, max)	-40 °C ... +125 °C
Conductors stripping length	9...11 mm
UL 94 flammability rating	V-0

Material properties

Main material	Polycarbonate (PC)
Other materials	Contacts: copper alloy
Colour	RAL 7032 grey
RoHs conformity	Compliant with exemption 6(c): copper alloy containing up to 4% lead by weight
China RoHs - EFUP	50
REACH SVHC substances	Yes Lead
SCIP number	1a9c93ff-0445-4a16-81e3-1609ac5274d6

Approvals / Standards

Reference standard	EN 61984:2009-06
Certifications	CSA, CQC, DNV, BV, EAC
UL	ECBT2

General ordering information

EAN13 code	8015747115728
eCl@ss 8.1	27440205
ETIM 7.0	EC000438

Packaging Information

Packaging length	240,00 mm
Packaging height	220,00 mm
Packaging width	210,00 mm
Packaging weight	4,21 kg
Packaging volume	11,09 dm ³
Packaging description	Carton box
Packaging quantity	30 Pcs
Packaging EAN code	8015747215633
Sub-packaging length	197,00 mm
Sub-packaging height	44,00 mm
Sub-packaging width	113,00 mm
Sub-packaging weight	0,70 kg
Sub-packaging volume	0,98 dm ³
Sub-packaging description	Carton tray
Sub-packaging quantity	5 Pcs
Sub-packaging EAN barcode	8015747115773

Part number

CSSF 16



Catalogue drawings

Catalogue drawings

CSSF / CSSM 16

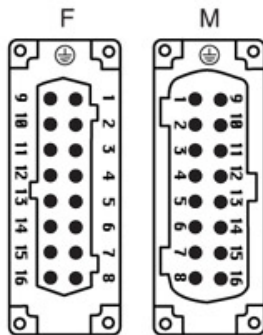
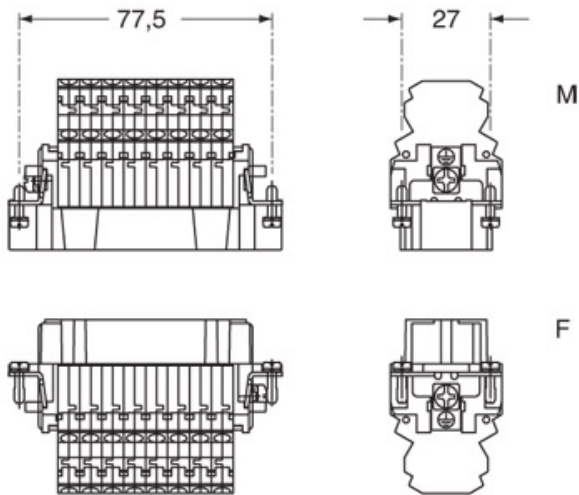
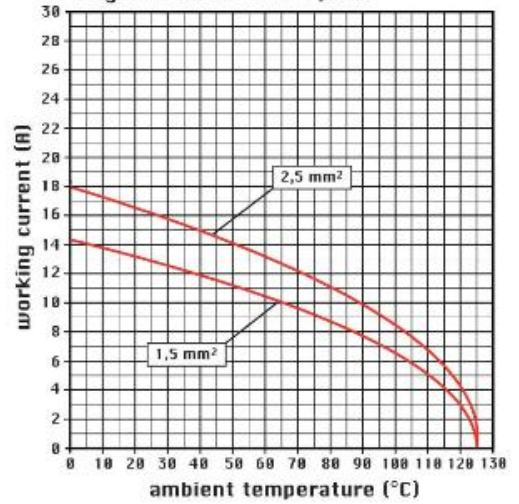
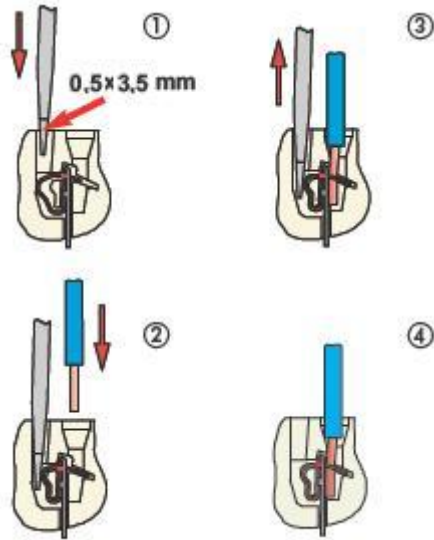

diagram CSS 16 and 32 poles



Notes



California Proposition 65 Information



WARNING

This product can expose you to lead and its compounds, known to the State of California to cause cancer and/or reproductive toxicity. For more information go to www.P65Warnings.ca.gov.