

Part number

CR 15 AD2



Adapter plate, size "44.27", for two 15 poles D-SUB inserts

Product description

Product type	Adapter plate
Size	Size 44.27
Specification	For two 15 poles D-SUB inserts

Further technical details

Weight	4,00 g
---------------	--------

General ordering information

EAN13 code	8015747037587
eCl@ss 8.1	27440201
ETIM 7.0	EC002309

Packaging Information

Sub-packaging weight	0,04 kg
Sub-packaging description	Carton box
Sub-packaging quantity	10 Pcs
Sub-packaging EAN barcode	8015747037594

Part number

CR 15 AD2



Catalogue drawings

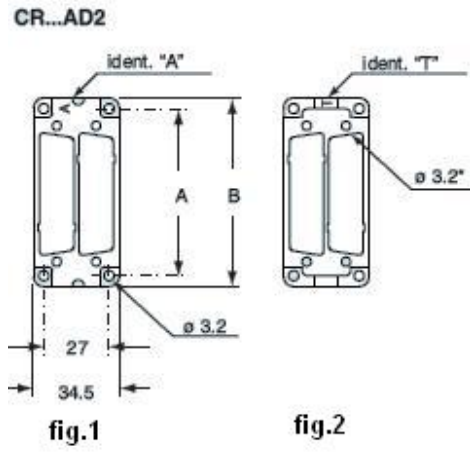

Notes