

Part number

# CR 09 AD1

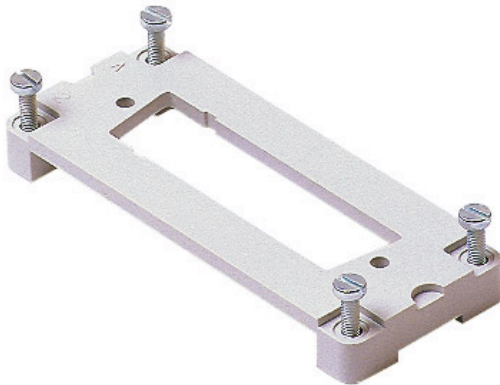

Adapter plate, size "44.27", for one 9 poles D-SUB insert

#### Product description

<b>Product type</b>	Adapter plate
<b>Size</b>	Size 44.27
<b>Specification</b>	For one 9 poles D-SUB insert

#### Further technical details

<b>Weight</b>	6,50 g
---------------	--------

#### General ordering information

<b>EAN13 code</b>	8015747037501
<b>eCl@ss 8.1</b>	27440201
<b>ETIM 7.0</b>	EC002309

#### Packaging Information

<b>Sub-packaging weight</b>	0,07 kg
<b>Sub-packaging description</b>	Carton box
<b>Sub-packaging quantity</b>	10 Pcs
<b>Sub-packaging EAN barcode</b>	8015747037518

Part number

# CR 09 AD1



## Catalogue drawings

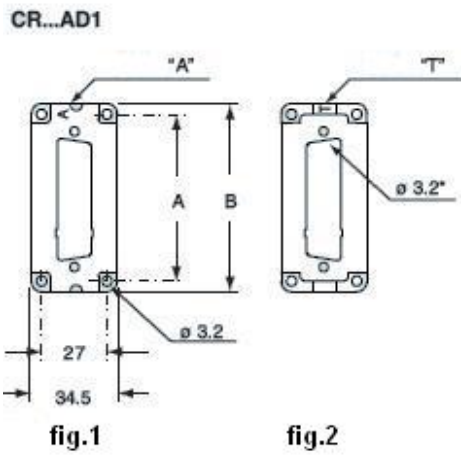

---

Notes