

Part number

# CR 06 SC



Cable anchorage, for multiple shielded PE cables, for inserts size "44.27"

#### Product description

<b>Product type</b>	Cable anchorage
<b>Size</b>	Size 44.27
<b>Specification</b>	For standard inserts, for multiple shielded PE cables In zinc plated iron

#### Further technical details

<b>Weight</b>	15,00 g
---------------	---------

#### General ordering information

<b>EAN13 code</b>	8015747149112
<b>eCl@ss 8.1</b>	27449290
<b>ETIM 7.0</b>	EC002943

#### Packaging Information

<b>Sub-packaging weight</b>	0,02 kg
<b>Sub-packaging description</b>	Plastic bag
<b>Sub-packaging quantity</b>	1 Pcs
<b>Sub-packaging EAN barcode</b>	8015747166973

Part number

# CR 06 SC



Catalogue drawings

## CR...SC

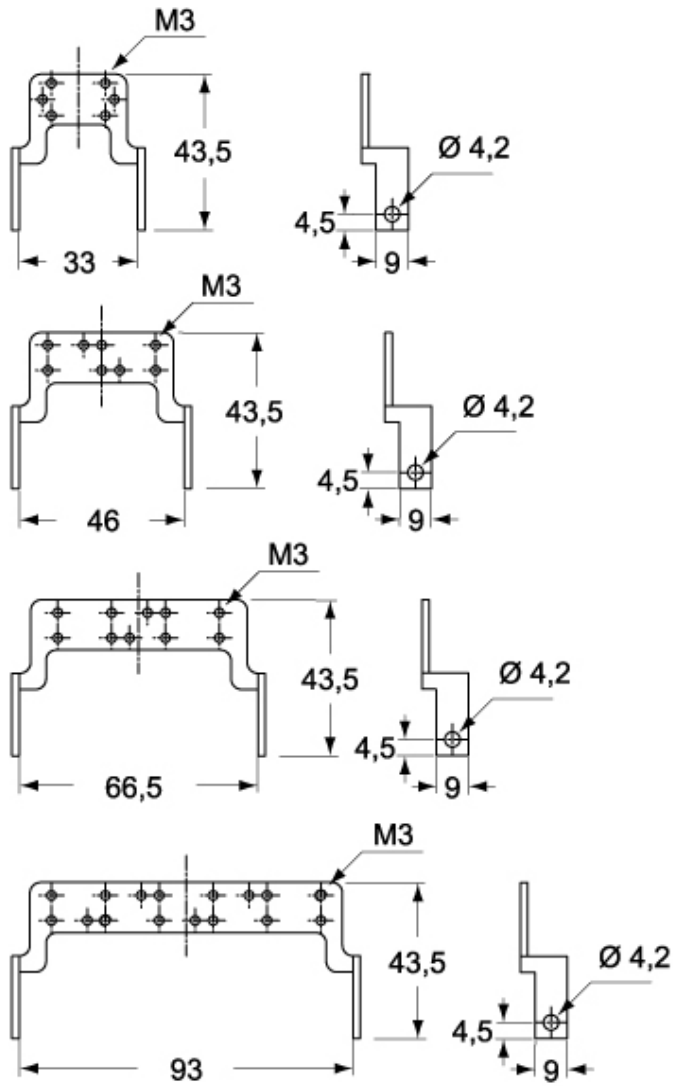

## CR...CA

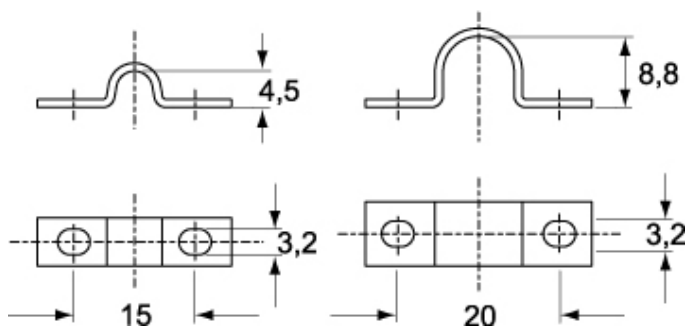

Notes

