

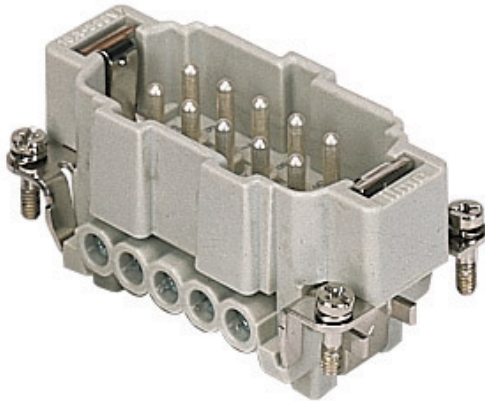

Part number

CNEM 10 T



Male insert, CNE series, screw terminal connection, 10 poles + PE, 16 A 500 V 6 kV 3, size "57.27", with plate

Product description

Product type	Insert
Series	CNE
Connection type	Screw terminal connection
Gender	Male
N. of poles	10 poles + 
Size	Size 57.27
Specification	With plate, also for non-prepared conductors

Technical data

Current	16 A
Voltage	500 V
Rated impulse withstand voltage	6 kV
Pollution degree	3
Rated voltage according to UL/CSA	600 V
Wire cross-section	0,50 mm ² - 4,00 mm ²
AWG size	20 - 12
Contact type	Turned silver plated
IP degree of protection	IP20 without enclosure, IP65/IP66/IP68/IP69 with enclosure

Further technical details

Characteristics according to EN 61984	16A 500V 6kV 3; 16A 400/690V 6kV 2
Mating cycles	≥ 500
Insulation resistance	≥ 10 GΩ
Contact resistance	≤ 1 mΩ
Weight	62,00 g
Operating temperature range (min, max)	-40 °C ... +125 °C
Conductors stripping length	7 mm
UL 94 flammability rating	V-0
Torque for main contact	M3: 0,5 Nm; 4,4 lb.in (Ph0 or 0,8 x 4 mm)

Material properties

Main material	Polycarbonate (PC)
Other materials	Contacts: copper alloy
Colour	RAL 7032 grey
RoHs conformity	Compliant with exemption 6(c): copper alloy containing up to 4% lead by weight
China RoHs - EFUP	50
REACH SVHC substances	Yes Lead
SCIP number	1a9c93ff-0445-4a16-81e3-1609ac5274d6

Approvals / Standards

Reference standard	EN 61984:2009-06
Certifications	CSA, CQC, DNV, BV, EAC
UL	ECBT2, PVVA2
cUL	ECBT8, PVVA8

General ordering information

EAN13 code	8015747032919
eCl@ss 8.1	27440205
ETIM 7.0	EC000438

Packaging Information

Packaging length	210,00 mm
Packaging height	75,00 mm
Packaging width	180,00 mm
Packaging weight	2,10 kg
Packaging volume	2,84 dm ³
Packaging description	Carton box
Packaging quantity	30 Pcs
Packaging EAN code	8015747032926
Sub-packaging length	67,00 mm
Sub-packaging height	36,00 mm
Sub-packaging width	180,00 mm
Sub-packaging weight	0,35 kg
Sub-packaging volume	0,43 dm ³
Sub-packaging description	Carton tray
Sub-packaging quantity	5 Pcs
Sub-packaging EAN barcode	8015747032933

Part number

CNEM 10 T



Catalogue drawings

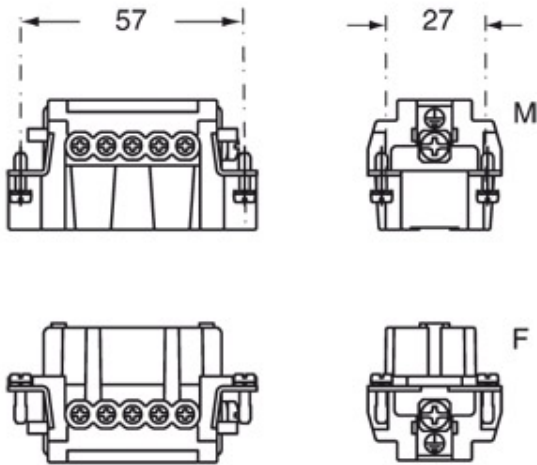

Catalogue drawings

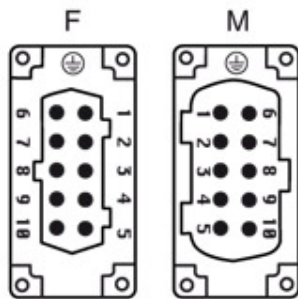
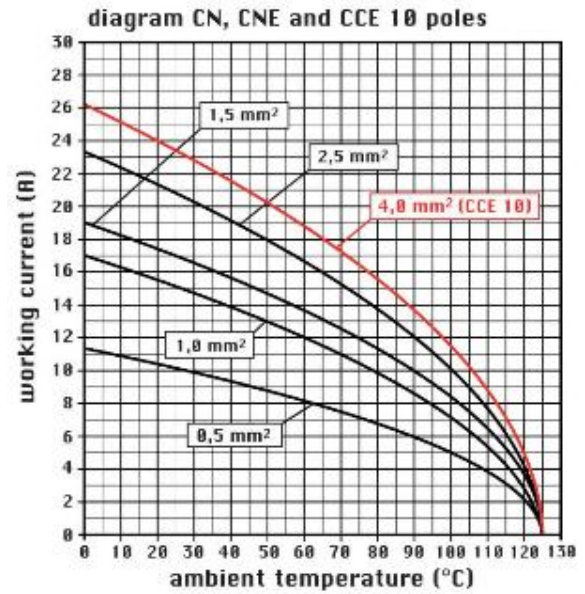

Notes

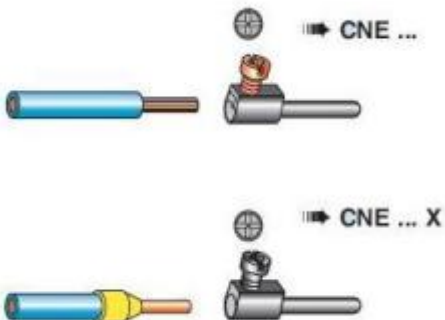

California Proposition 65 Information



WARNING

This product can expose you to lead and its compounds, known to the State of California to cause cancer and/or reproductive toxicity. For more information go to www.P65Warnings.ca.gov.

California Proposition 65 Information



WARNING

This product can expose you to lead and its compounds, known to the State of California to cause cancer and/or reproductive toxicity. For more information go to www.P65Warnings.ca.gov.
