

Part number

CMI 06 L



Bulkhead mounting housing, 830V series, with 1 lever, size "77.27"



Product description

Product type	Bulkhead mounting housing
Series	830V
Closing type	With 1 lever
Size	Size 77.27
Cable entry	Without cable entry

Technical data

IP degree of protection	IP65 / IP66 / IP69
--------------------------------	--------------------

Further technical details

Weight	126,50 g
Operating temperature range (min, max)	-40°C...+125°C

Material properties

Colour	RAL 7040 grey
RoHs conformity	Compliant
China RoHs - EFUP	E
REACH SVHC substances	No

Approvals / Standards

Certifications	DNV, BV
UL	ECBT2
cUL	ECBT8

General ordering information

EAN13 code	8015747030663
-------------------	---------------

Packaging Information

Packaging length	475,00 mm
Packaging height	220,00 mm
Packaging width	200,00 mm
Packaging weight	2,84 kg
Packaging volume	20,90 dm ³
Packaging description	Carton box
Packaging quantity	20 Pcs
Packaging EAN code	8015747234160
Sub-packaging weight	0,71 kg
Sub-packaging description	Plastic packaging
Sub-packaging quantity	5 Pcs
Sub-packaging EAN barcode	8015747030670

Part number

CMI 06 L



Catalogue drawings

CMI L

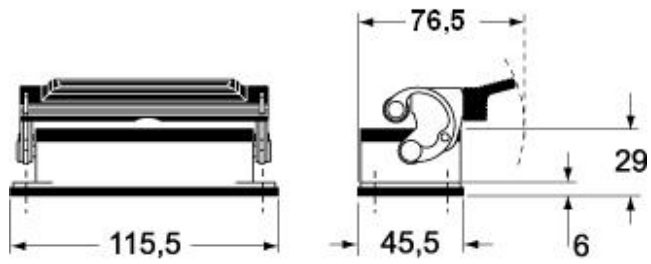

CMI LS

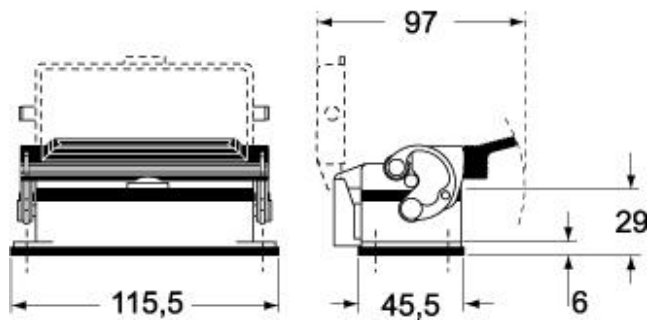

Catalogue drawings

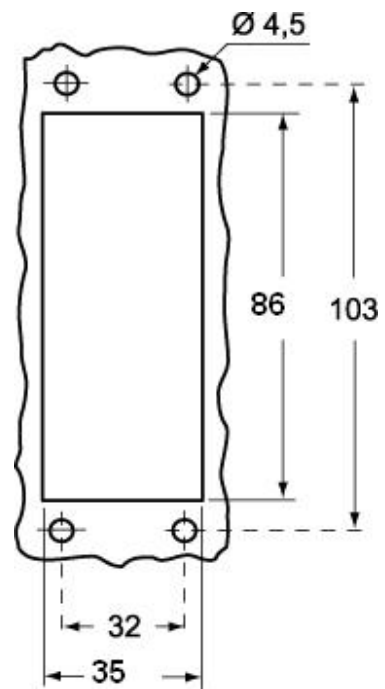

Notes