

Part number

CMAO 16.21



Hood, 830V series, with 4 pegs, Pg21 side cable entry, size "104.27", high construction

Product description		Material properties	
Product type	Hood	Colour	RAL 7040 grey
Series	830V	RoHs conformity	Compliant
Closing type	With 4 pegs	China RoHs - EFUP	E
Size	Size 104.27	REACH SVHC substances	No
Cable entry	Side cable entry Pg21	Approvals / Standards	
Specification	High construction	Certifications	DNV, BV
Technical data		UL	ECBT2
IP degree of protection	IP65 / IP66 / IP69	cUL	ECBT8
Further technical details		General ordering information	
Weight	231,00 g	EAN13 code	8015747028912
Operating temperature range (min, max)	-40°C...+125°C	Packaging Information	
		Sub-packaging weight	1,16 kg
		Sub-packaging description	Plastic packaging
		Sub-packaging quantity	5 Pcs
		Sub-packaging EAN barcode	8015747028929

Part number

CMAO 16.21



Catalogue drawings

**CMO [CMAO] CMV (CMAV) - MMO [MMAO]
MMV (MMAV)**

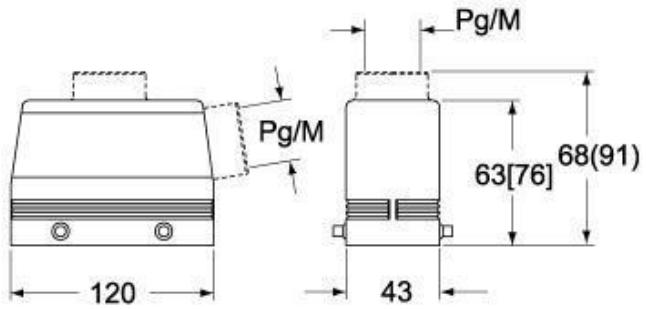

CMV G (CMAV G) - MMV G (MMAV G) - [MMFV G]

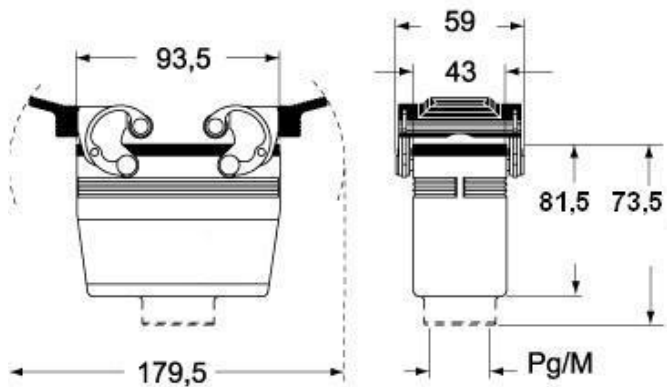

Notes