

Part number

CHIW 16



Bulkhead mounting housing, W-TYPE series, with 2 levers, size "77.27"

Product description

Product type	Bulkhead mounting housing
Series	W-TYPE
Closing type	With 2 levers
Size	Size 77.27
Cable entry	Without cable entry

Technical data

IP degree of protection IP65 / IP66 / IP69

Further technical details

Weight	180,50 g
Operating temperature range (min, max)	-40°C...+125°C

Material properties

Other materials	Lever: Stainless steel, polyamide (PA)
Colour	RAL 9005 black
RoHs conformity	Compliant
China RoHs - EFUP	E
REACH SVHC substances	No

Approvals / Standards

Certifications	DNV, BV
UL	ECBT2
cUL	ECBT8

General ordering information

EAN13 code	8015747019422
eCl@ss 8.1	27440202
ETIM 7.0	EC000437

Packaging Information

Packaging length	295,00 mm
Packaging height	160,00 mm
Packaging width	300,00 mm
Packaging weight	3,62 kg
Packaging volume	14,16 dm ³
Packaging description	Carton box
Packaging quantity	20 Pcs
Packaging EAN code	8015747297592
Sub-packaging weight	0,91 kg
Sub-packaging description	Plastic packaging
Sub-packaging quantity	5 Pcs
Sub-packaging EAN barcode	8015747125895

Part number

CHIW 16



Catalogue drawings

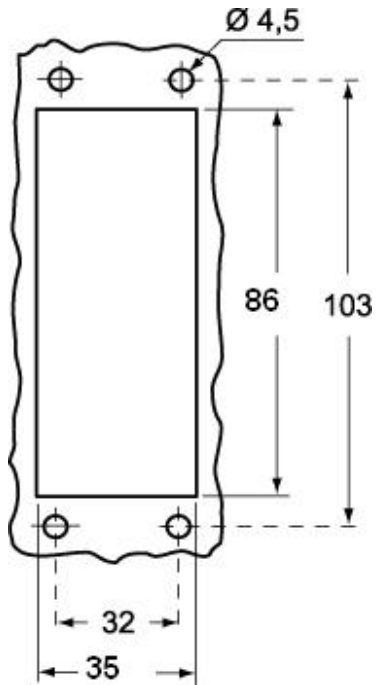

Catalogue drawings

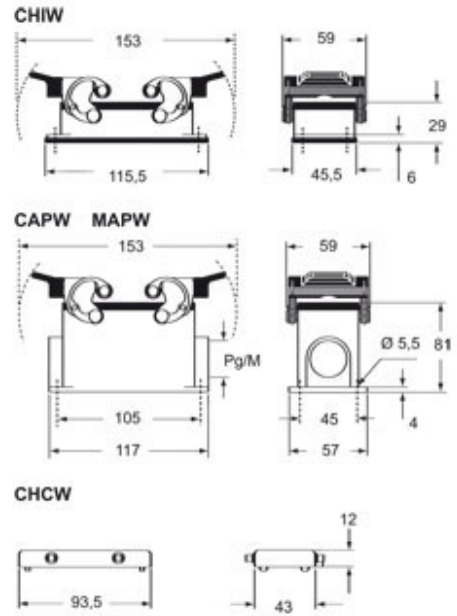

Notes