

Part number
CGT 25



PE terminal adapter, wire terminal adapter 25 mm² (AWG 4)



Product description		Material properties	
Product type	PE terminal adapter	RoHs conformity	Compliant with exemption 6(c): copper alloy containing up to 4% lead by weight
Specification	For MIXO inserts Nickel-plated	China RoHs - EFUP	50
Technical data		REACH SVHC substances	Yes Lead
Wire cross-section	25,00 mm ²	SCIP number	5e01cfb1-f424-4348-b68e-90952292bfef
AWG size	4	General ordering information	
Further technical details		EAN13 code	8015747262644
Weight	6,00 g	eCl@ss 8.1	27449290
		ETIM 7.0	EC000796
		Packaging Information	
		Sub-packaging length	50,00 mm
		Sub-packaging height	44,00 mm
		Sub-packaging width	50,00 mm
		Sub-packaging weight	0,12 kg
		Sub-packaging volume	0,11 dm ³
		Sub-packaging description	Plastic box
		Sub-packaging quantity	20 Pcs
		Sub-packaging EAN barcode	8015747262675

Part number

CGT 25



Catalogue drawings

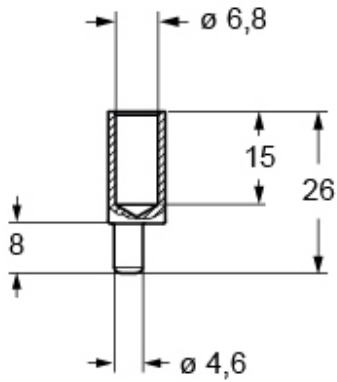

Notes

California Proposition 65 Information



WARNING

This product can expose you to lead and its compounds, known to the State of California to cause cancer and/or reproductive toxicity. For more information go to www.P65Warnings.ca.gov.