

Part number

CGO 16.36



Hood, IP68 series, with 2 screws, Pg36 side cable entry, size "77.27"

Product description		Material properties	
Product type	Hood	Main material	Aluminium die-cast
Series	IP68	Other materials	Screws: Stainless steel
Closing type	With 2 screws	Colour	RAL 9005 black
Size	Size 77.27	RoHs conformity	Compliant
Cable entry	Side cable entry Pg36	China RoHs - EFUP	E
Technical data		REACH SVHC substances	No
IP degree of protection	IP66 / IP68 / IP69	Approvals / Standards	
Further technical details		Certifications	DNV, BV
Weight	490,00 g	UL	ECBT2
Operating temperature range (min, max)	-40°C...+125°C	cUL	ECBT8
		General ordering information	
		EAN13 code	8015747142205
		Packaging Information	
		Packaging length	175,00 mm
		Packaging height	135,00 mm
		Packaging width	130,00 mm
		Packaging weight	0,98 kg
		Packaging volume	3,07 dm ³
		Packaging description	Carton box
		Packaging quantity	2 Pcs
		Packaging EAN code	8015747142748
		Sub-packaging weight	0,49 kg
		Sub-packaging description	Plastic packaging
		Sub-packaging quantity	1 Pcs
		Sub-packaging EAN barcode	8015747142755

Part number

CGO 16.36



Catalogue drawings

CGO/MGO CGV/MGV

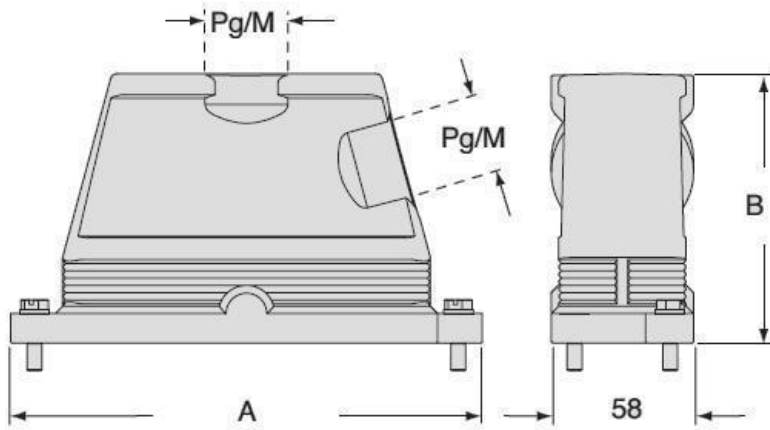

		A	B
CGO/MGO	CGV/MGV 06	133	101
CGO/MGO	CGV/MGV 10	146	101
CGO/MGO	CGV/MGV 16	166	111
CGO/MGO	CGV/MGV 24	193	111

Notes