

Part number

CGC 16 G



Cover, IP68 series, with 2 screws, size "77.27",
for hoods

Product description

Product type	Cover
Series	IP68
Closing type	With 2 screws
Size	Size 77.27
Cable entry	For hoods

Technical data

IP degree of protection	IP66 / IP68 / IP69
--------------------------------	--------------------

Further technical details

Weight	157,31 g
Operating temperature range (min, max)	-40°C...+125°C

Material properties

Main material	Aluminium die-cast
Other materials	Screws: Stainless steel
Colour	RAL 9005 black
RoHs conformity	Compliant
China RoHs - EFUP	E
REACH SVHC substances	No

General ordering information

EAN13 code	8015747292665
eCl@ss 8.1	27440208
ETIM 7.0	EC002314

Packaging Information

Sub-packaging length	167,00 mm
Sub-packaging height	21,00 mm
Sub-packaging width	60,00 mm
Sub-packaging weight	0,16 kg
Sub-packaging volume	0,21 dm ³
Sub-packaging description	Carton tray
Sub-packaging quantity	1 Pcs
Sub-packaging EAN barcode	8015747292672

Part number

CGC 16 G



Catalogue drawings

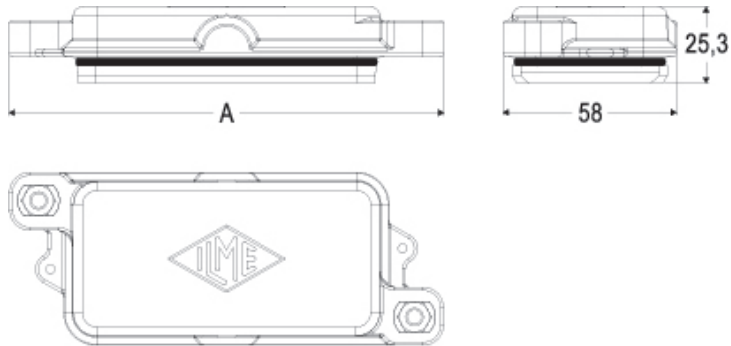

part No.	polarity	A
CGC 06 G	06	132,5
CGC 10 G	10	145,5
CGC 16 G	16	165,5
CGC 24 G	24	192,5

Catalogue drawings

Loop, for fixing on hoods

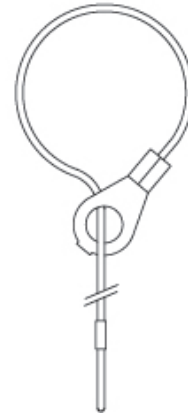

Notes