

Part number

CAV 10 X

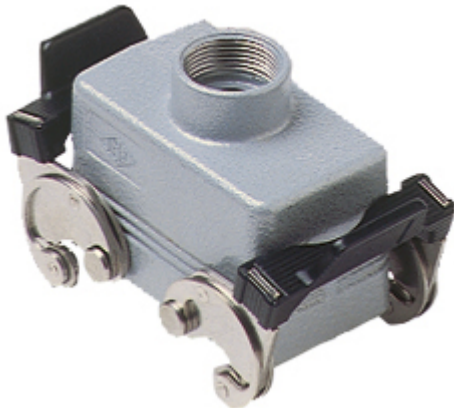

Hood, C-TYPE series, with 2 levers, Pg21 top cable entry, size "57.27", high construction, without gasket

Product description

Product type	Hood
Series	C-TYPE
Closing type	With 2 levers
Size	Size 57.27
Cable entry	Top cable entry Pg21
Specification	High construction, without gasket

Technical data

IP degree of protection	IP65 / IP66 / IP69
--------------------------------	--------------------

Further technical details

Weight	270,00 g
Operating temperature range (min, max)	-40°C...+125°C

Material properties

Other materials	Lever: Stainless steel, polyamide (PA)
Colour	RAL 7040 grey
RoHs conformity	Compliant
China RoHs - EFUP	E
REACH SVHC substances	No

Approvals / Standards

Certifications	DNV, BV
UL	ECBT2
cUL	ECBT8

General ordering information

EAN13 code	8015747009331
-------------------	---------------

Packaging Information

Packaging length	240,00 mm
Packaging height	120,00 mm
Packaging width	355,00 mm
Packaging weight	2,97 kg
Packaging volume	10,22 dm ³
Packaging description	Carton box
Packaging quantity	10 Pcs
Packaging EAN code	8015747225984
Sub-packaging weight	1,49 kg
Sub-packaging description	Plastic packaging
Sub-packaging quantity	5 Pcs
Sub-packaging EAN barcode	8015747009348

Part number

CAV 10 X



Catalogue drawings

CHO X (CAO X) - MHO X (MAO X)

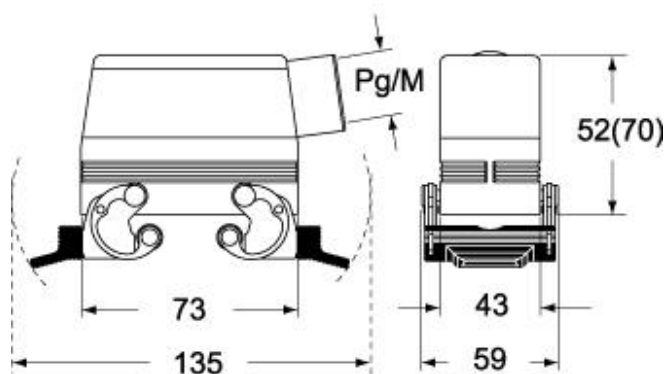

CHV X (CAV X) - MHV X (MAV X)

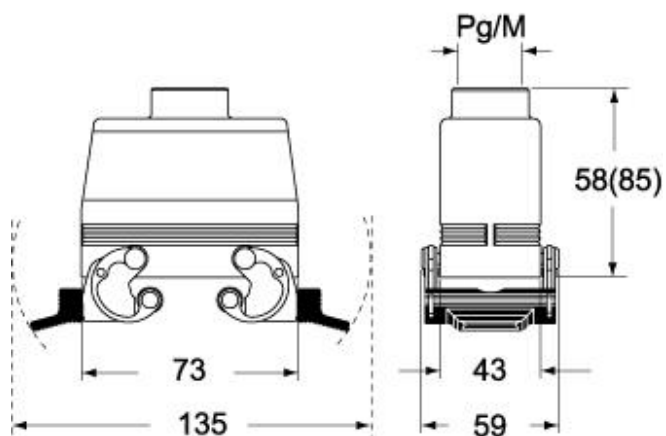

Notes