

Part number

# TM 1694 SIT



Interlocked switched socket-outlet, TM series, 3 poles + PE, 9 h (blue), 16 A, 200 ÷ 250 V, E16 fuse carrier, without base box

## Product description

<b>Product type</b>	Interlocked switched socket-outlet
<b>Series</b>	TM.. SIT
<b>N. of poles</b>	3 poles +
<b>Clock position</b>	9
<b>Size</b>	114 x 255 mm fixing distance, for assembly in single or multiple boxes
<b>Specification</b>	E16 fuse carrier Without base box

## Technical data

<b>Current</b>	16 A
<b>Voltage</b>	200 ÷ 250 V
<b>IP degree of protection</b>	IP66 / IP67

## Further technical details

<b>Weight</b>	1.383,00 g
<b>Operating temperature range (min, max)</b>	-25°C ... +40°C
<b>UL 94 flammability rating</b>	V-2
<b>IK rating (impact degree of protection)</b>	IK10

## Material properties

<b>Colour</b>	RAL 7012 grey, RAL 5015 blue
<b>RoHs conformity</b>	Compliant with exemption 6(c): copper alloy containing up to 4% lead by weight
<b>China RoHs - EFUP</b>	50
<b>REACH SVHC substances</b>	Yes Lead
<b>SCIP number</b>	Ce861c8d-b979-403b-96d9-80aef6dc281d

## Approvals / Standards

<b>Reference standard</b>	EN 60309-1, -2 e -4
---------------------------	---------------------

## General ordering information

<b>EAN13 code</b>	8015747090544
-------------------	---------------

## Packaging Information

<b>Packaging weight</b>	12,45 kg
<b>Packaging volume</b>	52,36 dm <sup>3</sup>
<b>Packaging description</b>	Carton box
<b>Packaging quantity</b>	9 Pcs
<b>Packaging EAN code</b>	8015747239370
<b>Sub-packaging length</b>	95,00 mm
<b>Sub-packaging height</b>	40,00 mm
<b>Sub-packaging width</b>	253,00 mm
<b>Sub-packaging weight</b>	1,38 kg
<b>Sub-packaging volume</b>	0,96 dm <sup>3</sup>
<b>Sub-packaging description</b>	Carton tray
<b>Sub-packaging quantity</b>	1 Pcs
<b>Sub-packaging EAN barcode</b>	8015747099189

Part number

# TM 1694 SIT



Catalogue drawings

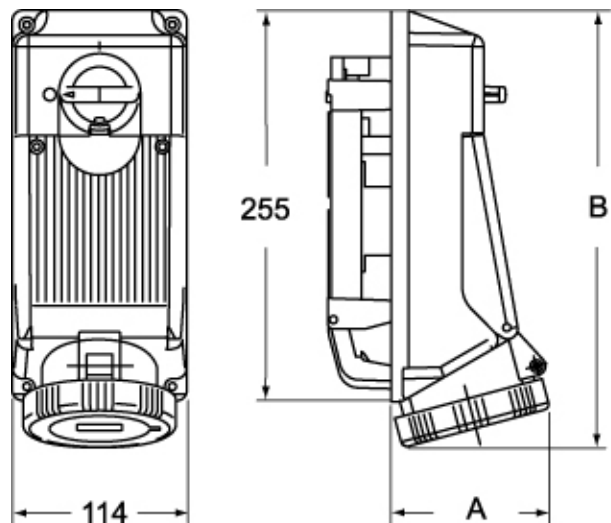

	<b>A</b>	<b>B</b>
<b>2P+⊕</b>	83	276
<b>3P+⊕</b>	85	276
<b>3P+N+⊕</b>	90	277