

Part number

TM 1664 SIS



Interlocked switched socket-outlet, TM series, 3 poles + PE, 6 h (red), 16 A, 380 ÷ 415 V, sectionable fuse carrier 10 x 38 mm, without base box

Product description		Material properties	
Product type	Interlocked switched socket-outlet	Colour	RAL 7012 grey, RAL 3000 red
Series	TM.. SIS/KSIS		Compliant with exemption 6(c): copper alloy containing up to 4% lead by weight
N. of poles	3 poles +	RoHs conformity	
Clock position	6	China RoHs - EFUP	50
Size	114 x 255 mm fixing distance, for assembly in single or multiple boxes	REACH SVHC substances	Yes Lead
Specification	Sectionable fuse carrier 10 x 38 mm Without base box	SCIP number	Ce861c8d-b979-403b-96d9-80aef6dc281d
Technical data		Approvals / Standards	
Current	16 A	Reference standard	EN 60309-1, -2 e -4
Voltage	380 ÷ 415 V	General ordering information	
IP degree of protection	IP66 / IP67	EAN13 code	8015747090056
Further technical details		Packaging Information	
Weight	1.280,00 g	Packaging weight	11,52 kg
Operating temperature range (min, max)	-25°C ... +40°C	Packaging volume	52,36 dm ³
UL 94 flammability rating	V-2	Packaging description	Carton box
IK rating (impact degree of protection)	IK10	Packaging quantity	9 Pcs
		Packaging EAN code	8015747090063
		Sub-packaging length	95,00 mm
		Sub-packaging height	40,00 mm
		Sub-packaging width	253,00 mm
		Sub-packaging weight	1,28 kg
		Sub-packaging volume	0,96 dm ³
		Sub-packaging description	Carton tray
		Sub-packaging quantity	1 Pcs
		Sub-packaging EAN barcode	8015747090070

Part number

TM 1664 SIS



Catalogue drawings

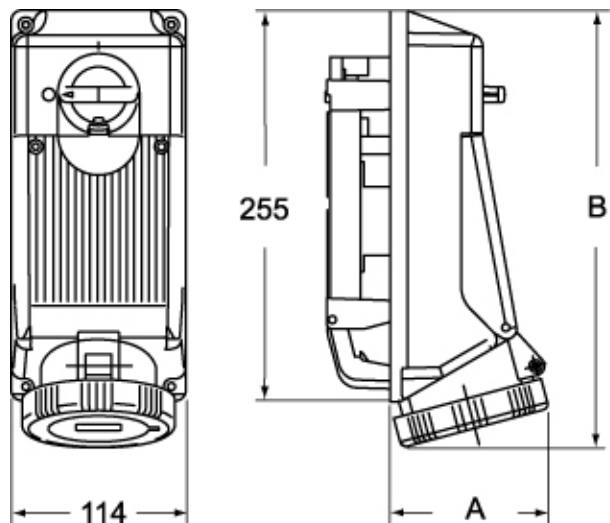

	A	B
2P+⊕	83	276
3P+⊕	85	276
3P+N+⊕	90	277
