

Part number

SQV 1624



Interlocked switched socket-outlet, SQV series, 3 poles + PE, 2 h (green), 16 A, > 50 V, sectionable fuse carrier 10 x 38 mm

Product description	
Product type	Interlocked switched socket-outlet
Series	SQV
N. of poles	3 poles + 
Clock position	2
Specification	Sectionable fuse carrier 10 x 38 mm
Technical data	
Current	16 A
Voltage	> 50 V
IP degree of protection	IP44
Further technical details	
Operating temperature range (min, max)	-25°C ... +40°C
IK rating (impact degree of protection)	IK08

Material properties	
Colour	RAL 7035 grey, RAL 6017 green
Approvals / Standards	
Reference standard	EN 60309-1, -2 e -4
General ordering information	
EAN13 code	8015747160162

Part number

SQV 1624



Catalogue drawings

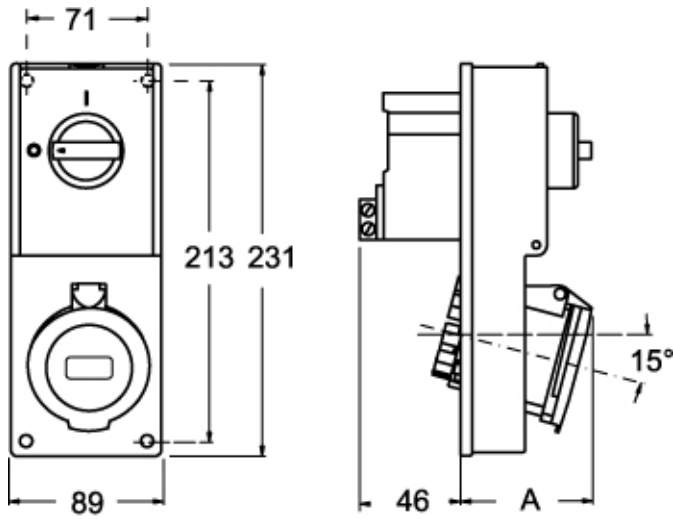

Catalogue drawings

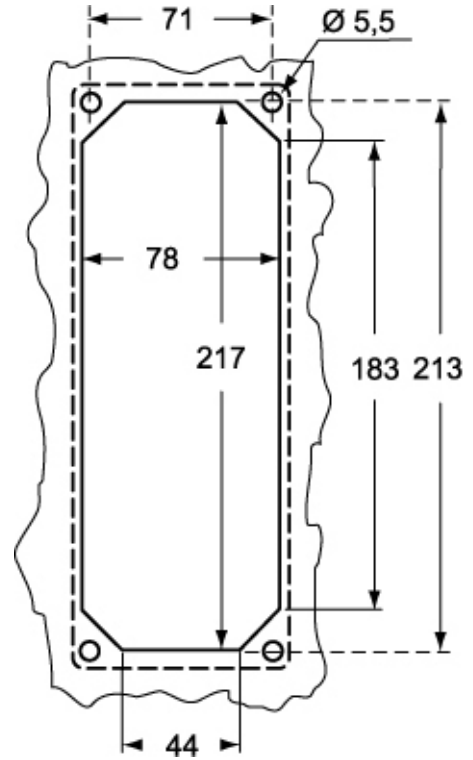

SQV		A
16A	2P+⊕	64
	3P+⊕	65
	3P+N+⊕	67