

Part number

# SIPW 3265 SM



Wall-mounting plug, PLUSO series, 3 poles + N + PE, 6 h (red), 32 A, 200/346 ÷ 240/415 V, with phase inverter

Product description		Material properties	
<b>Product type</b>	Plug Wall-mounting	<b>Colour</b>	RAL 7035 grey, RAL 3000 red
<b>Series</b>	SIPW...SM, PLUSO		Compliant with exemption 6(c): copper alloy containing up to 4% lead by weight
<b>Connection type</b>	Screw terminal connection	<b>RoHs conformity</b>	
<b>N. of poles</b>	3 poles + N + 	<b>China RoHs - EFUP</b>	50
<b>Clock position</b>	6	<b>REACH SVHC substances</b>	Yes Lead
<b>Specification</b>	With phase inverter	<b>SCIP number</b>	Ca7de37f-add8-4b77-9861-279c94903ade
Technical data		Approvals / Standards	
<b>Current</b>	32 A	<b>Reference standard</b>	EN 60309-1 and -2
<b>Voltage</b>	200/346 ÷ 240/415 V	General ordering information	
<b>IP degree of protection</b>	IP67	<b>EAN13 code</b>	8015747084055
Further technical details		Packaging Information	
<b>Weight</b>	380,00 g	<b>Packaging weight</b>	3,80 kg
<b>Operating temperature range (min, max)</b>	-25°C ... +40°C	<b>Packaging volume</b>	36,36 dm <sup>3</sup>
		<b>Packaging description</b>	Carton box
		<b>Packaging quantity</b>	10 Pcs
		<b>Packaging EAN code</b>	8015747084062

Part number

# SIPW 3265 SM



Catalogue drawings

Catalogue drawings

SIP ... SM

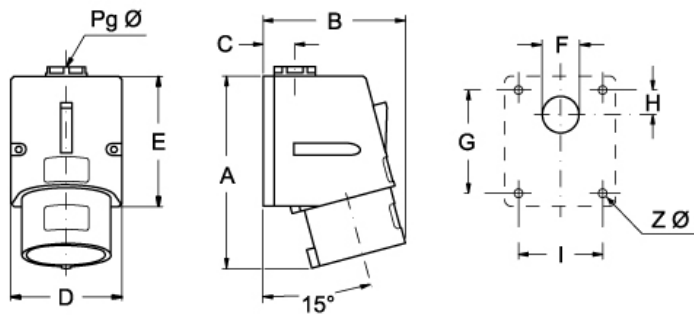

	A	B	C	D	E	F	G	H	I	Z Ø	Pg Ø
<b>16A</b>	121	90	20	70	82	23	65	16	53	4,3	16
<b>32A</b>	147	95	24	86	104	29	79	17	61	6,3	21

SIPW ... SM

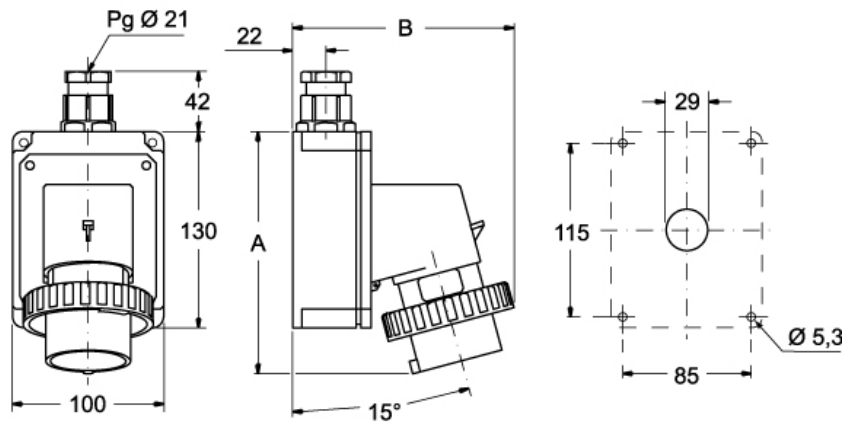

	A	B
<b>16A</b>	164	145
<b>32A</b>	178	160