

Part number

# SIM1D 0.2C

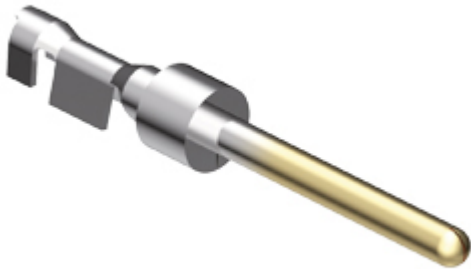

Male crimp contact, SI series, 5 A, stamped gold plated, wire cross section 0,08 - 0,21 mm<sup>2</sup>, AWG 28 - 24, coil packaging, for 500 mating cycles

#### Product description

<b>Product type</b>	Crimp contact
<b>Series</b>	SI
<b>Gender</b>	Male
<b>Specification</b>	Coil packaging For 500 mating cycles

#### Technical data

<b>Current</b>	5 A
<b>Wire cross-section</b>	0,08 mm <sup>2</sup> - 0,21 mm <sup>2</sup>
<b>AWG size</b>	28 - 24
<b>Contact type</b>	Stamped gold plated

#### Further technical details

<b>Contact resistance</b>	≤ 10 mΩ
<b>Weight</b>	0,21 g
<b>Conductors stripping length</b>	3 mm

#### Material properties

<b>RoHS conformity</b>	Compliant
<b>China RoHS - EFUP</b>	E
<b>REACH SVHC substances</b>	No

#### Approvals / Standards

<b>Certifications</b>	EAC
<b>UL</b>	ECBT2
<b>cUL</b>	ECBT8

#### General ordering information

<b>EAN13 code</b>	8015747276955
<b>eCl@ss 8.1</b>	27440204
<b>ETIM 7.0</b>	EC000796

#### Packaging Information

<b>Packaging weight</b>	0,12 kg
<b>Packaging description</b>	Plastic bag
<b>Packaging quantity</b>	500 Pcs
<b>Packaging EAN code</b>	8015747188661

Part number

# SIM1D 0.2C



Catalogue drawings

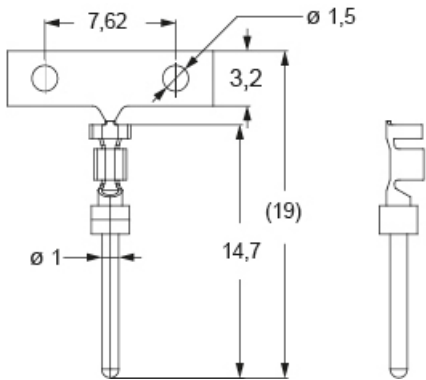

SIM..D C

