

Part number

# PEW 3294 SM



Wall-mounting plug, PLUSO series, 3 poles + PE, 9 h (blue), 32 A, 200 ÷ 250 V

Product description		Material properties	
<b>Product type</b>	Plug Wall-mounting	<b>Colour</b>	RAL 7035 grey, RAL 5015 blue
<b>Series</b>	PEW...SM, PLUSO	<b>RoHs conformity</b>	Compliant with exemption 6(c): copper alloy containing up to 4% lead by weight
<b>N. of poles</b>	3 poles + 	<b>China RoHs - EFUP</b>	50
<b>Clock position</b>	9	<b>REACH SVHC substances</b>	Yes Lead
Technical data		<b>SCIP number</b>	Ca7de37f-add8-4b77-9861-279c94903ade
<b>Current</b>	32 A	Approvals / Standards	
<b>Voltage</b>	200 ÷ 250 V	<b>Reference standard</b>	EN 60309-1 and -2
<b>IP degree of protection</b>	IP67	General ordering information	
Further technical details		<b>EAN13 code</b>	8015747076289
<b>Weight</b>	468,00 g	Packaging Information	
<b>Operating temperature range (min, max)</b>	-25°C ... +40°C	<b>Packaging weight</b>	5,27 kg
		<b>Packaging volume</b>	36,36 dm <sup>3</sup>
		<b>Packaging description</b>	Carton box
		<b>Packaging quantity</b>	10 Pcs
		<b>Packaging EAN code</b>	8015747076296

Part number

# PEW 3294 SM



Catalogue drawings

(16 / 32A) PEW ... SM

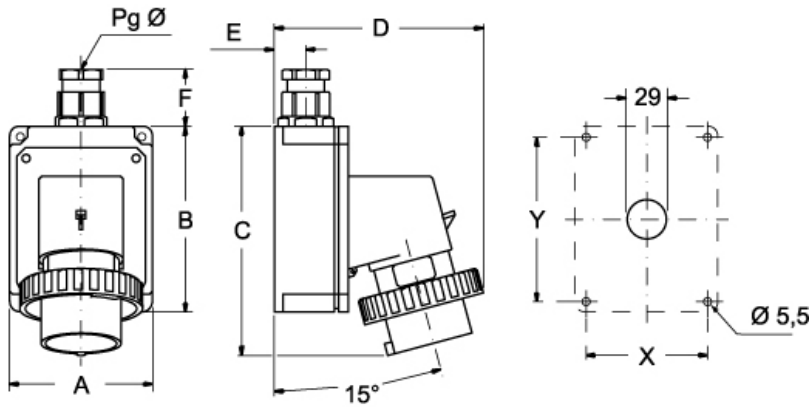

PEW ... SM	A	B	C	D	E	F	X	Y	Pg Ø
<b>16A</b> 2P+⊕	75	115	144	126	19	35	65	105	16
3P+⊕	75	115	144	134	19	35	65	105	16
3P+N+⊕	100	130	164	145	22	42	85	115	21
<b>32A</b> 2P+⊕	100	130	178	154	22	42	85	115	21
3P+⊕	100	130	178	154	22	42	85	115	21
3P+N+⊕	100	130	178	160	22	42	85	115	21