

Part number

PEW 3293 PP



Wall-mounting socket outlet, PLUSO series, 2 poles + PE, 9 h (red), 32 A, 380 ÷ 415 V

Product description

Product type	Socket Wall-mounting
Series	PEW...PP, PLUSO
N. of poles	2 poles + 
Clock position	9

Technical data

Current	32 A
Voltage	380 ÷ 415 V
IP degree of protection	IP67

Further technical details

Weight	452,00 g
Operating temperature range (min, max)	-25°C ... +40°C

Material properties

Colour	RAL 7035 grey, RAL 3000 red
RoHs conformity	Compliant with exemption 6(c): copper alloy containing up to 4% lead by weight
China RoHs - EFUP	50
REACH SVHC substances	Yes Lead
SCIP number	Ca7de37f-add8-4b77-9861-279c94903ade

Approvals / Standards

Reference standard	EN 60309-1 and -2
---------------------------	-------------------

General ordering information

EAN13 code	8015747076043
-------------------	---------------

Packaging Information

Packaging length	440,00 mm
Packaging height	180,00 mm
Packaging width	330,00 mm
Packaging weight	5,01 kg
Packaging volume	26,14 dm ³
Packaging description	Carton box
Packaging quantity	10 Pcs
Packaging EAN code	8015747076050

Part number

PEW 3293 PP



Catalogue drawings

(16 / 32A) PEW ... PP

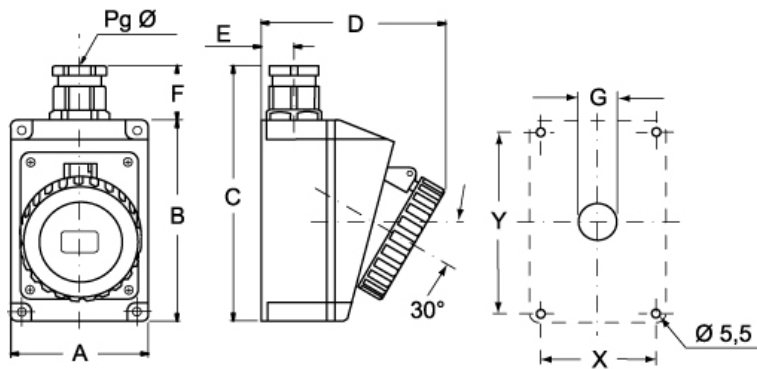

PEW ... PP	A	B	C	D	E	F	G	X	Y	Pg Ø
16A 2P+⊕	75	115	150	105	19	33	Ø22	65	105	16
3P+⊕	75	115	150	108	19	33	Ø22	65	105	16
3P+N+⊕	100	130	172	120	22	33	Ø22	85	115	21
32A 2P+⊕	100	130	172	120	22	42	Ø28	85	115	21
3P+⊕	100	130	172	120	22	42	Ø28	85	115	21
3P+N+⊕	100	130	172	120	22	42	Ø28	85	115	21