

Part number

PEW 3275 SI



Flush-mounting plug, PLUSO series, 3 poles + N + PE, 7 h (black), 32 A, 277/480 ÷ 288/500 V

Product description

Product type	Plug Flush-mounting
Series	PEW...SI, PLUSO
N. of poles	3 poles + N + 
Clock position	7

Technical data

Current	32 A
Voltage	277/480 ÷ 288/500 V
IP degree of protection	IP67

Further technical details

Weight	300,00 g
Operating temperature range (min, max)	-25°C ... +40°C

Material properties

Colour	RAL 7035 grey, RAL 9005 black
RoHs conformity	Compliant with exemption 6(c): copper alloy containing up to 4% lead by weight
China RoHs - EFUP	50
REACH SVHC substances	Yes Lead
SCIP number	Ca7de37f-add8-4b77-9861-279c94903ade

Approvals / Standards

Reference standard	EN 60309-1 and -2
---------------------------	-------------------

General ordering information

EAN13 code	8015747075978
-------------------	---------------

Packaging Information

Packaging length	355,00 mm
Packaging height	195,00 mm
Packaging width	325,00 mm
Packaging weight	3,44 kg
Packaging volume	22,50 dm ³
Packaging description	Carton box
Packaging quantity	10 Pcs
Packaging EAN code	8015747075985

Part number

PEW 3275 SI



Catalogue drawings

(16 / 32A) PEW ... SI

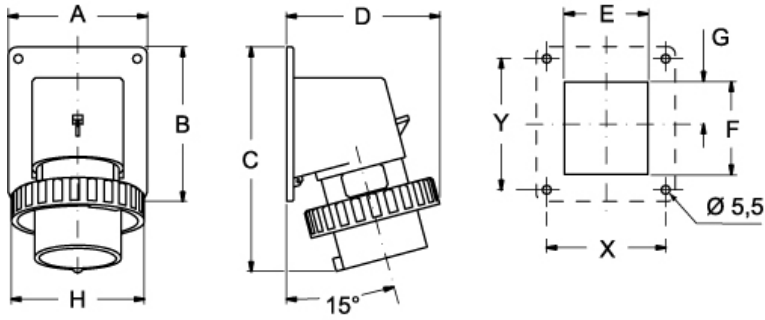

PEW ... SI	A	B	C	D	E	F	G	H	X	Y
16A 2P+⊕	65	82	126	81	41	43	21,5	70	52	60
3P+⊕	65	82	126	81	47	43	24,5	78	52	60
3P+N+⊕	90	100	146	93	54	60	27,5	86	77	85
32A 2P+⊕	90	100	160	101	55	60	27,5	92	77	85
3P+⊕	90	100	160	101	55	60	27,5	92	77	85
3P+N+⊕	90	100	160	101	62	60	27,5	100	77	85