

Part number

PEW 3273 SI



Flush-mounting plug, PLUSO series, 2 poles + PE, 7 h (black), 32 A, 480 ÷ 500 V

Product description

Product type	Plug Flush-mounting
Series	PEW...SI, PLUSO
N. of poles	2 poles + 
Clock position	7

Technical data

Current	32 A
Voltage	480 ÷ 500 V
IP degree of protection	IP67

Further technical details

Operating temperature range (min, max)	-25°C ... +40°C
---	-----------------

Material properties

Colour	RAL 7035 grey, RAL 9005 black
---------------	-------------------------------

Approvals / Standards

Reference standard	EN 60309-1 and -2
---------------------------	-------------------

General ordering information

EAN13 code	8015747158046
-------------------	---------------

Part number

PEW 3273 SI



Catalogue drawings

(16 / 32A) PEW ... SI

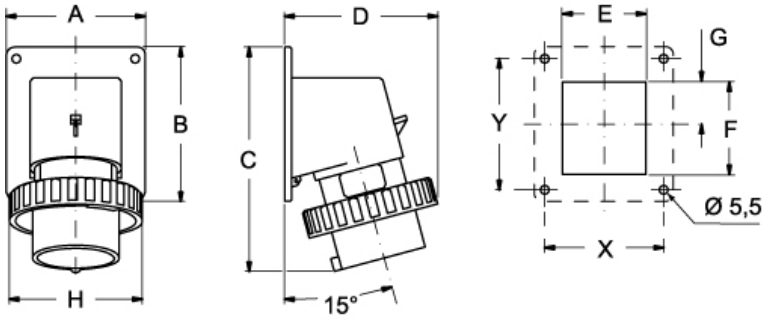

PEW ... SI	A	B	C	D	E	F	G	H	X	Y	
16A	2P+⊕	65	82	126	81	41	43	21,5	70	52	60
	3P+⊕	65	82	126	81	47	43	24,5	78	52	60
	3P+N+⊕	90	100	146	93	54	60	27,5	86	77	85
32A	2P+⊕	90	100	160	101	55	60	27,5	92	77	85
	3P+⊕	90	100	160	101	55	60	27,5	92	77	85
	3P+N+⊕	90	100	160	101	62	60	27,5	100	77	85