

Part number

PE 1673 PP



Wall-mounting socket outlet, PLUSO series, 2 poles + PE, 7 h (black), 16 A, 480 ÷ 500 V

Product description

Product type	Socket Wall-mounting
Series	PE...PP, PLUSO
N. of poles	2 poles + 
Clock position	7

Technical data

Current	16 A
Voltage	480 ÷ 500 V
IP degree of protection	IP44

Further technical details

Operating temperature range (min, max)	-25°C ... +40°C
---	-----------------

Material properties

Colour	RAL 7035 grey, RAL 9005 black
---------------	-------------------------------

Approvals / Standards

Reference standard	EN 60309-1 and -2
---------------------------	-------------------

General ordering information

EAN13 code	8015747155052
-------------------	---------------

Part number

PE 1673 PP



Catalogue drawings

(16 / 32A) PE ... PP

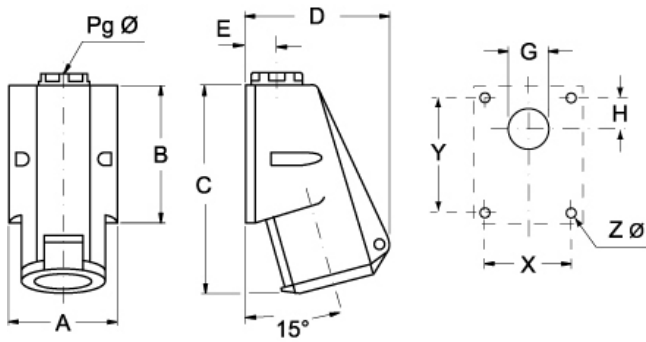

PE ... PP	A	B	C	D	E	G	H	X	Y	Pg Ø	Z Ø	
16A	2P+⊕	70	82	126	92	20	Ø22	16	53	65	16	4,5
	3P+⊕	70	82	126	92	20	Ø22	16	53	65	16	4,5
	3P+N+⊕	70	82	132	106	20	Ø22	16	53	65	16	4,5
32A	2P+⊕	86	104	159	110	24	Ø28	17	61	79	21	6,5
	3P+⊕	86	104	159	110	24	Ø28	17	61	79	21	6,5
	3P+N+⊕	86	104	159	110	24	Ø28	17	61	79	21	6,5