

Part number

PE 1673 PIF



Flush-mounting socket outlet, PLUSO series, 2 poles + PE, 7 h (black), 16 A, 480 ÷ 500 V, inclined, with bigger flange

Product description

Product type	Socket Flush-mounting
Series	PE...PIF, PLUSO
N. of poles	2 poles + 
Clock position	7
Specification	Inclined, bigger flange

Technical data

Current	16 A
Voltage	480 ÷ 500 V
IP degree of protection	IP44

Further technical details

Operating temperature range (min, max)	-25°C ... +40°C
---	-----------------

Material properties

Colour	RAL 7035 grey, RAL 9005 black
---------------	-------------------------------

Approvals / Standards

Reference standard	EN 60309-1 and -2
---------------------------	-------------------

General ordering information

EAN13 code	8015747155045
-------------------	---------------

Part number

PE 1673 PIF



Catalogue drawings

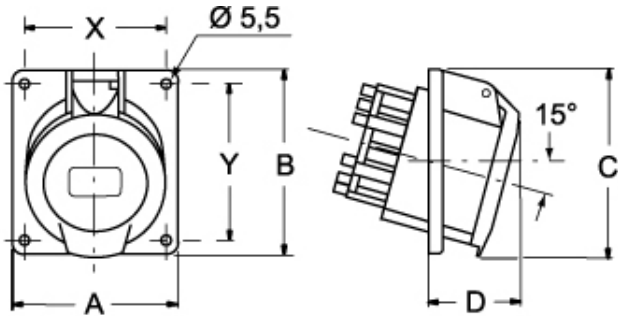

			A	B	C	D	X	Y
PIF	16 A	2P+⊕	92	100	--	52	77	85
		3P+⊕	92	100	--	53	77	85
PI	16 A	2P+⊕	64	82	--	38	52	60
		3P+⊕	64	82	--	42	52	60
		3P+N+⊕	92	100	--	43	77	60
PI	32 A	2P+⊕	92	100	--	40	77	85
		3P+⊕	92	100	--	40	77	85
		3P+N+⊕	92	102	--	43	77	85