

Part number

MXA 02 AP25



Angled surface mounting housing, MIXO TWO series, with 1 lever, M25 top cable entry, with 1 lever, 2 modules, with PE connection terminal and contact

Product description

Product type	Angled surface mounting housing
Series	MIXO TWO
Closing type	With 1 lever
Size	2 modules
Cable entry	Top cable entry M25
Specification	With PE connection terminal and contact

Technical data

IP degree of protection	IP65
Further technical details	
Mating cycles	≥ 500
Weight	339,50 g
Operating temperature range (min, max)	-40°C...+125°C
Tightening torque for PE connection	1,2 Nm

Material properties

Main material	Zinc die-cast
Other materials	Lever: Polyamide (PA) and stainless steel core Gasket NBR
Colour	RAL 7040 grey
RoHs conformity	Compliant
China RoHs - EFUP	E
REACH SVHC substances	No

General ordering information

EAN13 code	8015747302845
eCl@ss 8.1	27440202
ETIM 7.0	EC000437

Packaging Information

Packaging length	160,00 mm
Packaging height	130,00 mm
Packaging width	270,00 mm
Packaging weight	3,63 kg
Packaging volume	5,62 dm ³
Packaging description	Carton box
Packaging quantity	10 Pcs
Packaging EAN code	8015747302876
Sub-packaging weight	0,36 kg
Sub-packaging description	Plastic bag
Sub-packaging quantity	1 Pcs
Sub-packaging EAN barcode	8015747302883

Part number

MXA 02 AP25



Catalogue drawings

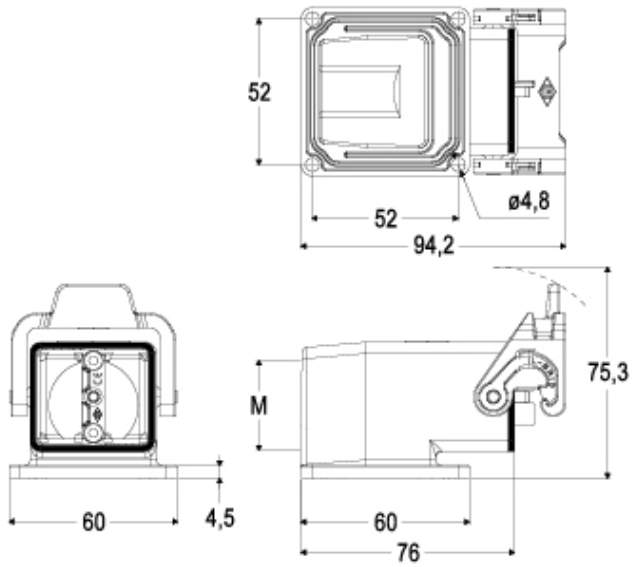

Catalogue drawings

