

Part number

# MMAP 06 LS32



Surface mounting housing, 830V series, with 1 lever, M32 cable entry, size "77.27", high construction, with metal cover

Product description	
<b>Product type</b>	Surface mounting housing
<b>Series</b>	830V
<b>Closing type</b>	With 1 lever
<b>Size</b>	Size 77.27
<b>Cable entry</b>	With cable entry M32
<b>Specification</b>	High construction, with metal cover
Technical data	
<b>IP degree of protection</b>	IP65
Further technical details	
<b>Weight</b>	450,00 g
<b>Operating temperature range (min, max)</b>	-40°C...+125°C

Material properties	
<b>Colour</b>	RAL 7040 grey
<b>RoHs conformity</b>	Compliant
<b>China RoHs - EFUP</b>	E
<b>REACH SVHC substances</b>	No
Approvals / Standards	
<b>Certifications</b>	DNV, BV
<b>UL</b>	ECBT2
<b>cUL</b>	ECBT8
General ordering information	
<b>EAN13 code</b>	8015747057530
Packaging Information	
<b>Sub-packaging weight</b>	0,45 kg
<b>Sub-packaging description</b>	Plastic packaging
<b>Sub-packaging quantity</b>	1 Pcs
<b>Sub-packaging EAN barcode</b>	8015747112871

Part number

# MMAP 06 LS32



Catalogue drawings

## CMP L CMAP L - MMP L MMAP L



## CMP LS CMAP LS - MMP LS MMAP LS

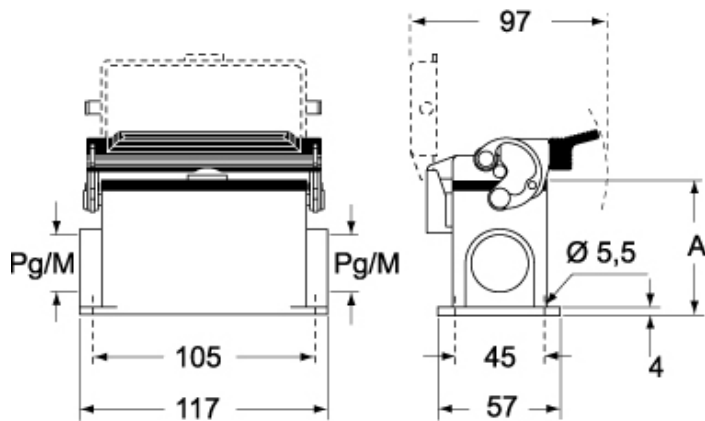

	<b>A</b>
<b>CMP L / MMP L</b>	63
<b>CMAP L / MMAP L</b>	77
<b>CMP LS / MMP LS</b>	63
<b>CMAP LS / MMAP LS</b>	77