

Part number

# MHP 32 LS240



Surface mounting housing, C-TYPE series, with 1 lever, M40 x 2 cable entry, size "77.62", with metal cover

#### Product description

<b>Product type</b>	Surface mounting housing
<b>Series</b>	C-TYPE
<b>Closing type</b>	With 1 lever
<b>Size</b>	Size 77.62
<b>Cable entry</b>	With cable entry M40 x 2
<b>Specification</b>	With metal cover

#### Technical data

**IP degree of protection** IP65

#### Further technical details

<b>Weight</b>	866,00 g
<b>Operating temperature range (min, max)</b>	-40°C...+125°C

#### Material properties

<b>Other materials</b>	Lever: Stainless steel, polyamide (PA) Gasket: NBR
<b>Colour</b>	RAL 7040 grey
<b>RoHs conformity</b>	Compliant
<b>China RoHs - EFUP</b>	E
<b>REACH SVHC substances</b>	No

#### Approvals / Standards

<b>Certifications</b>	DNV, BV
<b>UL</b>	ECBT2
<b>cUL</b>	ECBT8

#### General ordering information

<b>EAN13 code</b>	8015747054997
<b>eCl@ss 8.1</b>	27440202
<b>ETIM 7.0</b>	EC000437

#### Packaging Information

<b>Packaging length</b>	290,00 mm
<b>Packaging height</b>	140,00 mm
<b>Packaging width</b>	215,00 mm
<b>Packaging weight</b>	3,67 kg
<b>Packaging volume</b>	8,73 dm <sup>3</sup>
<b>Packaging description</b>	Carton box
<b>Packaging quantity</b>	4 Pcs
<b>Packaging EAN code</b>	8015747211147
<b>Sub-packaging weight</b>	0,92 kg
<b>Sub-packaging description</b>	Plastic packaging
<b>Sub-packaging quantity</b>	1 Pcs
<b>Sub-packaging EAN barcode</b>	8015747099820

Part number

# MHP 32 LS240



Catalogue drawings

## CHP L CAP L - MHP L MAP L

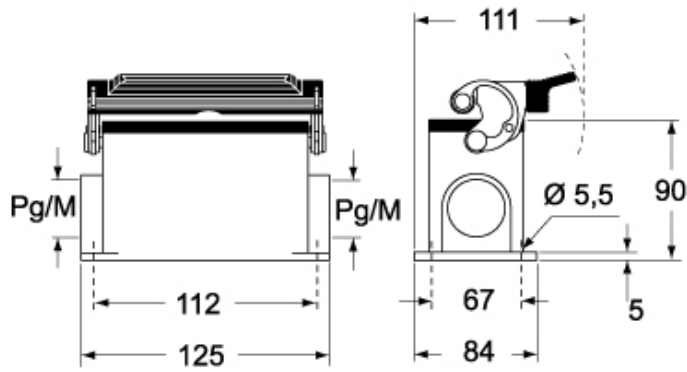

## CHP LS CAP LS - MHP LS MAP LS

