

Part number

MHO 48 L50



Hood, C-TYPE series, with 2 pegs, M50 side cable entry, size "104.62"



Product description

| | |
|---------------------|-----------------------------------|
| Product type | Hood |
| Series | C-TYPE |
| Closing type | With 2 pegs |
| Size | Size 104.62 |
| Cable entry | Side cable entry with adapter M50 |

Technical data

IP degree of protection IP65 / IP66 / IP69

Further technical details

| | |
|---|----------------|
| Weight | 645,00 g |
| Operating temperature range (min, max) | -40°C...+125°C |

Material properties

| | |
|------------------------------|--|
| Colour | RAL 7040 grey |
| RoHs conformity | Compliant with exemption 6(c): copper alloy containing up to 4% lead by weight |
| China RoHs - EFUP | 50 |
| REACH SVHC substances | Yes Lead |
| SCIP number | 15deaf78-e939-4401-a0b0-e2228ca32a03 |

Approvals / Standards

| | |
|-----------------------|---------|
| Certifications | DNV, BV |
| UL | ECBT2 |
| cUL | ECBT8 |

General ordering information

| | |
|-------------------|---------------|
| EAN13 code | 8015747053822 |
| eCl@ss 8.1 | 27440202 |
| ETIM 7.0 | EC000437 |

Packaging Information

| | |
|----------------------------------|----------------------|
| Packaging length | 255,00 mm |
| Packaging height | 150,00 mm |
| Packaging width | 180,00 mm |
| Packaging weight | 2,77 kg |
| Packaging volume | 6,89 dm ³ |
| Packaging description | Carton box |
| Packaging quantity | 4 Pcs |
| Packaging EAN code | 8015747256049 |
| Sub-packaging weight | 0,69 kg |
| Sub-packaging description | Plastic packaging |
| Sub-packaging quantity | 1 Pcs |
| Sub-packaging EAN barcode | 8015747053839 |

Part number

MHO 48 L50



Catalogue drawings

CHO L - MHO L - MFO L

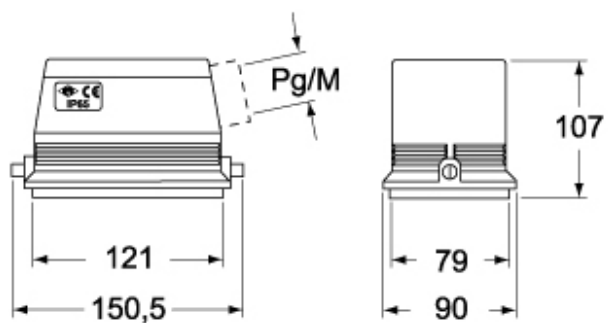

CHV L - MHV L - MFV L

