

Part number

MFV 10 G25



Hood, C-TYPE series, with 2 levers, M25 top cable entry without adapter, size "57.27", high construction

Product description

Product type	Hood
Series	C-TYPE
Closing type	With 2 levers
Size	Size 57.27
Cable entry	Top cable entry M25
Specification	High construction

Technical data

IP degree of protection	IP65 / IP66 / IP69
--------------------------------	--------------------

Further technical details

Weight	300,00 g
Operating temperature range (min, max)	-40°C...+125°C

Material properties

Other materials	Lever: Stainless steel, polyamide (PA) Gasket: NBR
Colour	RAL 7040 grey
RoHs conformity	Compliant
China RoHs - EFUP	E
REACH SVHC substances	No

Approvals / Standards

Certifications	DNV, BV
UL	ECBT2
cUL	ECBT8

General ordering information

EAN13 code	8015747152099
eCl@ss 8.1	27440202
ETIM 7.0	EC000437

Packaging Information

Sub-packaging weight	1,50 kg
Sub-packaging description	Plastic packaging
Sub-packaging quantity	5 Pcs
Sub-packaging EAN barcode	8015747219990

Part number

MFV 10 G25



Catalogue drawings

**CHO [CAO] CHV (CAV) - MHO [MAO]
MHV (MAV)**

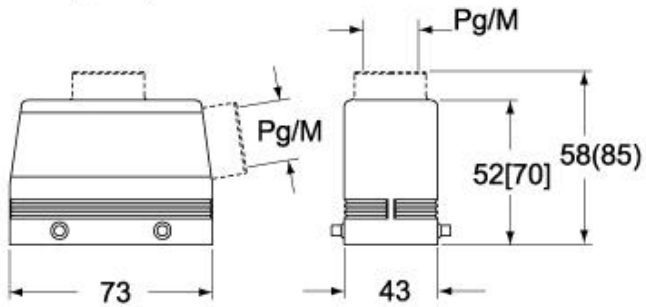

CAF - MAF/MFF



CHV G (CAV G) - MHV G (MAV G) - [MFV G]

