

Part number

# MAP 24 CP40



Surface mounting housing, C-TYPE series, with 4 pegs, M40 cable entry, size "104.27", high construction, with plastic cover

## Product description

<b>Product type</b>	Surface mounting housing
<b>Series</b>	C-TYPE
<b>Closing type</b>	With 4 pegs
<b>Size</b>	Size 104.27
<b>Cable entry</b>	With cable entry M40
<b>Specification</b>	High construction, with plastic cover

## Technical data

<b>IP degree of protection</b>	IP65
--------------------------------	------

## Further technical details

<b>Weight</b>	455,00 g
<b>Operating temperature range (min, max)</b>	-40°C...+125°C

## Material properties

<b>Other materials</b>	Gasket: NBR
<b>Colour</b>	RAL 7040 grey
<b>RoHs conformity</b>	Compliant
<b>China RoHs - EFUP</b>	E
<b>REACH SVHC substances</b>	No

## Approvals / Standards

<b>Certifications</b>	DNV, BV
<b>UL</b>	ECBT2
<b>cUL</b>	ECBT8

## General ordering information

<b>EAN13 code</b>	8015747051743
<b>eCl@ss 8.1</b>	27440202
<b>ETIM 7.0</b>	EC000437

## Packaging Information

<b>Packaging length</b>	475,00 mm
<b>Packaging height</b>	220,00 mm
<b>Packaging width</b>	200,00 mm
<b>Packaging weight</b>	5,00 kg
<b>Packaging volume</b>	20,90 dm <sup>3</sup>
<b>Packaging description</b>	Carton box
<b>Packaging quantity</b>	10 Pcs
<b>Packaging EAN code</b>	8015747257503
<b>Sub-packaging weight</b>	2,50 kg
<b>Sub-packaging description</b>	Plastic packaging
<b>Sub-packaging quantity</b>	5 Pcs
<b>Sub-packaging EAN barcode</b>	8015747105958

Part number

# MAP 24 CP40



Catalogue drawings

## CHP CAP - MHP MAP

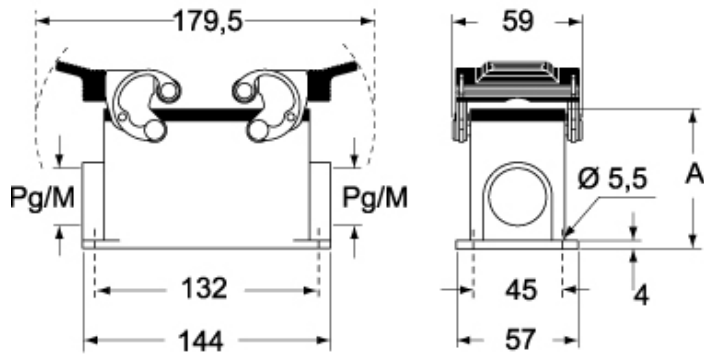

## CHP CS/CP CAP CS/CP - MHP CS/CP MAP CS/CP



	<b>A</b>
<b>CHP / MHP</b>	63
<b>CAP / MAP</b>	80
<b>CHP CS / MHP CS</b>	63
<b>CAP CS / MAP CS</b>	80
<b>CHP CP / MHP CP</b>	63
<b>CAP CP / MAP CP</b>	80