

Part number

# JCVP 10 L



Surface mounting housing, JEI®-V series, with 1 lever, Pg16 cable entry, size "57.27"

Product description		Material properties	
<b>Product type</b>	Surface mounting housing	<b>Other materials</b>	Lever: Galvanized steel Gasket: NBR
<b>Series</b>	JEI®-V	<b>Colour</b>	RAL 7040 grey
<b>Closing type</b>	With 1 lever	<b>Approvals / Standards</b>	
<b>Size</b>	Size 57.27	<b>Certifications</b>	DNV, BV
<b>Cable entry</b>	With cable entry Pg16	<b>UL</b>	ECBT2
<b>Technical data</b>		<b>cUL</b>	ECBT8
<b>IP degree of protection</b>	IP65 / IP66 / IP69	<b>General ordering information</b>	
<b>Further technical details</b>		<b>EAN13 code</b>	8015747137669
<b>Weight</b>	241,00 g	<b>Packaging Information</b>	
<b>Operating temperature range (min, max)</b>	-40°C...+125°C	<b>Packaging length</b>	180,00 mm
		<b>Packaging height</b>	105,00 mm
		<b>Packaging width</b>	270,00 mm
		<b>Packaging weight</b>	4,92 kg
		<b>Packaging volume</b>	5,10 dm <sup>3</sup>
		<b>Packaging description</b>	Carton box
		<b>Packaging quantity</b>	20 Pcs
		<b>Packaging EAN code</b>	8015747253512
		<b>Sub-packaging weight</b>	1,23 kg
		<b>Sub-packaging description</b>	Plastic packaging
		<b>Sub-packaging quantity</b>	5 Pcs
		<b>Sub-packaging EAN barcode</b>	8015747140294

Part number

# JCVP 10 L



Catalogue drawings

JCVP L

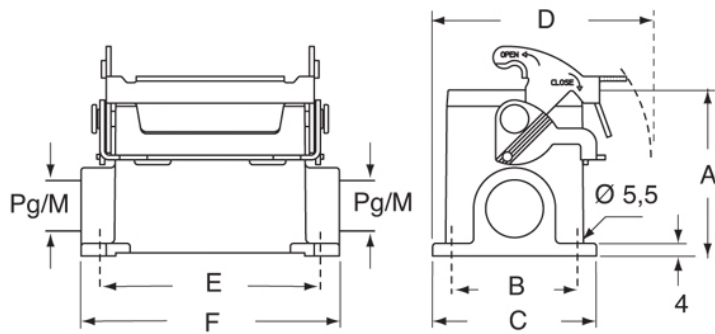

	A	B	C	D	E	F
JCVP 06 L	53	40	52	70	70	82
JCVP 10 L	57	40	52	73	82	93,5
JCVP 16 L	63	45	57	75,5	105	117
JCVP 24 L	63	45	57	75,5	132	144