

Part number

# FM 4272 CL



Box system for socket-outlet combinations, FM series, with smooth cover, alveolated on the rear

#### Product description

<b>Product type</b>	Box system for socket-outlet combinations
<b>Series</b>	FM
<b>Size</b>	420 x 720 x 135 mm
<b>Specification</b>	With smooth cover, alveolated on the rear

#### Technical data

<b>IP degree of protection</b>	IP55
--------------------------------	------

#### Further technical details

<b>Weight</b>	4.555,00 g
<b>Operating temperature range (min, max)</b>	-40°C ... +125°C

#### Material properties

<b>Colour</b>	RAL 7035 grey
---------------	---------------

#### General ordering information

<b>EAN13 code</b>	8015747047746
-------------------	---------------

#### Packaging Information

<b>Packaging length</b>	430,00 mm
<b>Packaging height</b>	150,00 mm
<b>Packaging width</b>	730,00 mm
<b>Packaging weight</b>	5,40 kg
<b>Packaging volume</b>	47,09 dm <sup>3</sup>
<b>Packaging description</b>	Carton box
<b>Packaging quantity</b>	1 Pcs
<b>Packaging EAN code</b>	8015747047753

Part number

# FM 4272 CL



Catalogue drawings

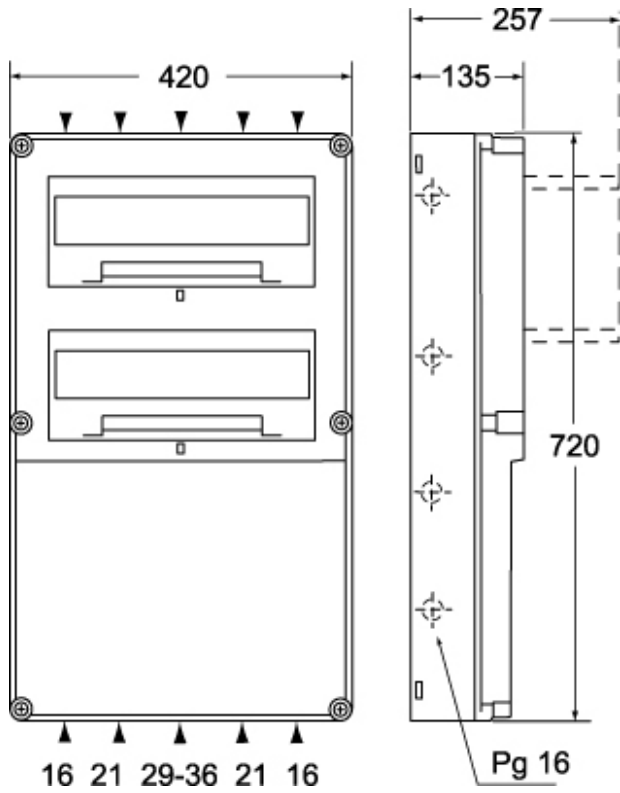

Catalogue drawings

