

Part number

FC 2814 DB5



Box, FC series, with fixed cover, for 2 FC 1453 TB plates

Product description

Product type	Box
Series	FC
Specification	With fixed cover For 2 FC 1453 TB plates

Technical data

IP degree of protection IP55

Further technical details

Weight 621,00 g

Material properties

Colour RAL 7035 grey

General ordering information

EAN13 code 8015747046541

Packaging Information

Packaging length	360,00 mm
Packaging height	165,00 mm
Packaging width	315,00 mm
Packaging weight	2,85 kg
Packaging volume	18,71 dm ³
Packaging description	Carton box
Packaging quantity	4 Pcs
Packaging EAN code	8015747046558
Sub-packaging weight	0,71 kg
Sub-packaging description	Plastic bag
Sub-packaging quantity	1 Pcs
Sub-packaging EAN barcode	8015747046565

Part number

FC 2814 DB5



Catalogue drawings

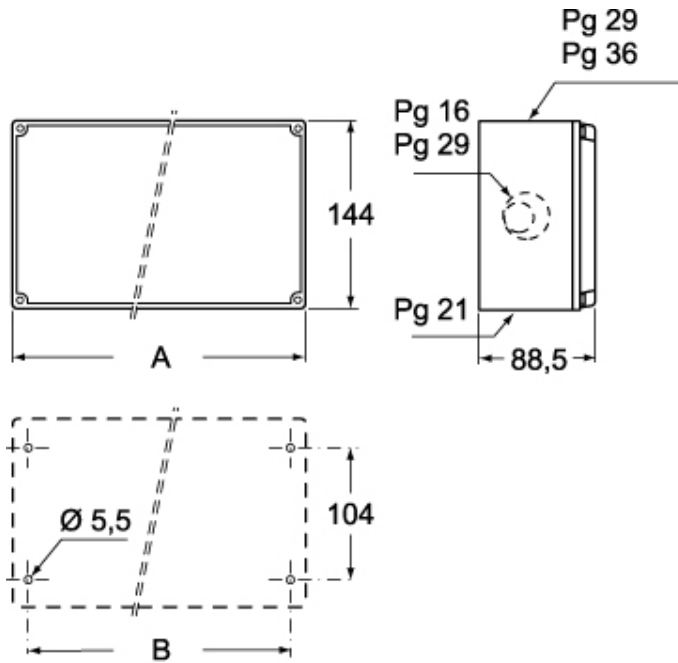

	A	B
FC 2214 DB5	228	210
FC 2514 DB5	260	239
FC 2814 DB5	290	269