

Part number

CVP 10 LSP16



Surface mounting housing, V-TYPE series, with 1 lever, Pg16 cable entry, size "57.27", with SIMPLEX self-closing cover

Product description	
Product type	Surface mounting housing
Series	V-TYPE
Closing type	With 1 lever
Size	Size 57.27
Cable entry	With cable entry Pg16
Specification	With SIMPLEX self-closing cover
Technical data	
IP degree of protection	IP65
Further technical details	
Operating temperature range (min, max)	-40°C...+125°C

Material properties	
Other materials	Lever: Stainless steel Gasket: NBR
Colour	RAL 7040 grey
RoHs conformity	Compliant
China RoHs - EFUP	E
REACH SVHC substances	No
Approvals / Standards	
Certifications	DNV, BV
UL	ECBT2
cUL	ECBT8
General ordering information	
EAN13 code	8015747267335

Part number

CVP 10 LSP16



Catalogue drawings

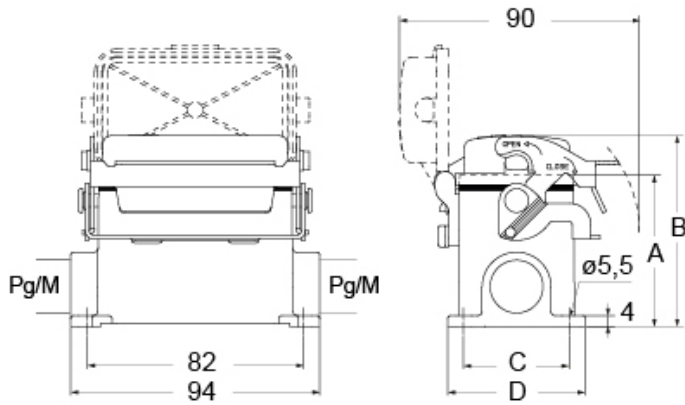

part No.	A	B	C	D
CVP / MVP 10 LSP	57	72	40	52
CVAP / MVAP 10 LSP	74	89	45	57
