

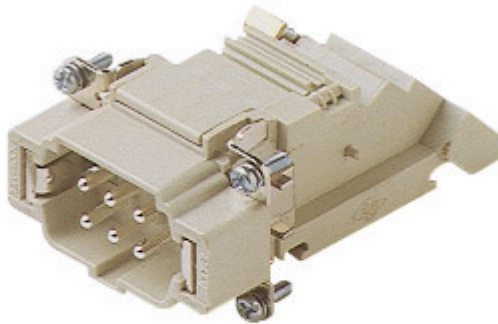

Part number

# CTSEM 06 L



Male insert, CTSE series, spring terminal connection, 6 poles + PE, 16 A 500 V 6 kV 3, size "44.27", with incorporated terminal block, left side mounting

## Product description

<b>Product type</b>	Insert
<b>Series</b>	CTSE
<b>Connection type</b>	Spring terminal connection
<b>Gender</b>	Male
<b>N. of poles</b>	6 poles + 
<b>Size</b>	Size 44.27
<b>Specification</b>	Left side mounting With incorporated terminal block

## Technical data

<b>Current</b>	16 A
<b>Voltage</b>	500 V
<b>Rated impulse withstand voltage</b>	6 kV
<b>Pollution degree</b>	3
<b>Rated voltage according to UL/CSA</b>	600 V
<b>Wire cross-section</b>	0,14 mm <sup>2</sup> - 2,50 mm <sup>2</sup>
<b>AWG size</b>	26 - 14
<b>Contact type</b>	Turned silver plated
<b>IP degree of protection</b>	IP20 without enclosure, IP66/IP69 with enclosure

## Further technical details

<b>Characteristics according to EN 61984</b>	16A 500V 6kV 3; 16A 400/690V 6kV 2
<b>Mating cycles</b>	≥ 500
<b>Insulation resistance</b>	≥ 10 GΩ
<b>Contact resistance</b>	≤ 4 mΩ
<b>Weight</b>	79,00 g
<b>Operating temperature range (min, max)</b>	-40 °C ... +125 °C
<b>Conductors stripping length</b>	9...11 mm
<b>UL 94 flammability rating</b>	V-0

## Material properties

<b>Main material</b>	Polycarbonate (PC)
<b>Other materials</b>	Contacts: copper alloy
<b>Colour</b>	RAL 7032 grey
<b>RoHs conformity</b>	Compliant with exemption 6(c): copper alloy containing up to 4% lead by weight
<b>China RoHs - EFUP</b>	50
<b>REACH SVHC substances</b>	Yes Lead
<b>SCIP number</b>	1a9c93ff-0445-4a16-81e3-1609ac5274d6

## Approvals / Standards

<b>Reference standard</b>	EN 61984:2009-06
<b>Certifications</b>	CSAc, CQC, DNV, BV, EAC
<b>UL</b>	ECBT2

## General ordering information

<b>EAN13 code</b>	8015747122436
<b>eCl@ss 8.1</b>	27440205
<b>ETIM 7.0</b>	EC000438

## Packaging Information

<b>Packaging weight</b>	0,42 kg
<b>Packaging description</b>	Carton box
<b>Packaging quantity</b>	4 Pcs
<b>Packaging EAN code</b>	8015747123754
<b>Sub-packaging length</b>	75,00 mm
<b>Sub-packaging height</b>	89,00 mm
<b>Sub-packaging width</b>	110,00 mm
<b>Sub-packaging weight</b>	0,11 kg
<b>Sub-packaging volume</b>	0,73 dm <sup>3</sup>
<b>Sub-packaging description</b>	Plastic packaging
<b>Sub-packaging quantity</b>	1 Pcs
<b>Sub-packaging EAN barcode</b>	8015747123761

Part number

# CTSEM 06 L



Catalogue drawings

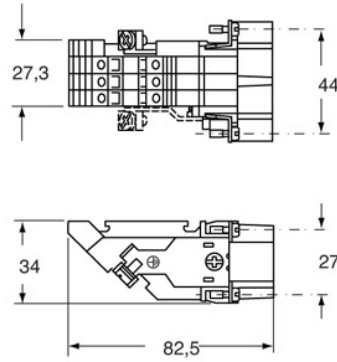
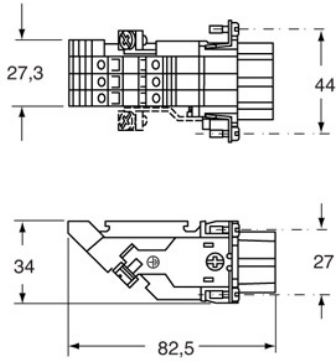

Catalogue drawings

