

Part number

CMAP 06LS229



Surface mounting housing, 830V series, with 1 lever, Pg29 x 2 cable entry, size "77.27", high construction, with metal cover

Product description	
Product type	Surface mounting housing
Series	830V
Closing type	With 1 lever
Size	Size 77.27
Cable entry	With cable entry Pg29 x 2
Specification	High construction, with metal cover
Technical data	
IP degree of protection	IP65
Further technical details	
Operating temperature range (min, max)	-40°C...+125°C

Material properties	
Colour	RAL 7040 grey
RoHs conformity	Compliant
China RoHs - EFUP	E
REACH SVHC substances	No
Approvals / Standards	
Certifications	DNV, BV
UL	ECBT2
cUL	ECBT8
General ordering information	
EAN13 code	8015747029407
Packaging Information	
Sub-packaging description	Plastic packaging
Sub-packaging quantity	5 Pcs
Sub-packaging EAN barcode	8015747105842

Part number

CMAP 06LS229



Catalogue drawings

CMP L CMAP L - MMP L MMAP L

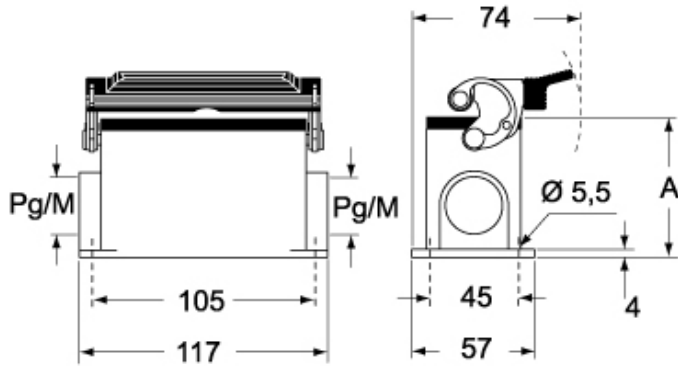

CMP LS CMAP LS - MMP LS MMAP LS

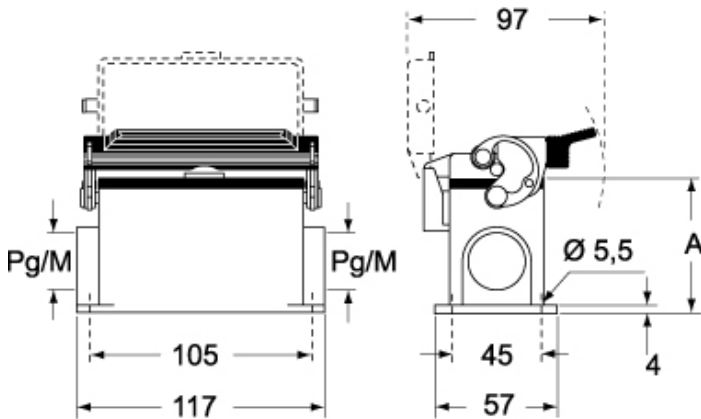

	A
CMP L / MMP L	63
CMAP L / MMAP L	77
CMP LS / MMP LS	63
CMAP LS / MMAP LS	77