

Part number

CMAP 06CS229



Surface mounting housing, 830V series, with 4 pegs, Pg29 x 2 cable entry, size "77.27", high construction, with metal cover

Product description

Product type	Surface mounting housing
Series	830V
Closing type	With 4 pegs
Size	Size 77.27
Cable entry	With cable entry Pg29 x 2
Specification	High construction, with metal cover

Technical data

IP degree of protection IP65

Further technical details

Operating temperature range (min, max) -40°C...+125°C

Material properties

Colour	RAL 7040 grey
RoHs conformity	Compliant
China RoHs - EFUP	E
REACH SVHC substances	No
Approvals / Standards	
Certifications	DNV, BV
UL	ECBT2
cUL	ECBT8

General ordering information

EAN13 code 8015747029391

Packaging Information

Sub-packaging description	Plastic packaging
Sub-packaging quantity	1 Pcs
Sub-packaging EAN barcode	8015747120999

Part number

CMAP 06CS229



Catalogue drawings

CMP CMAP - MMP MMAP

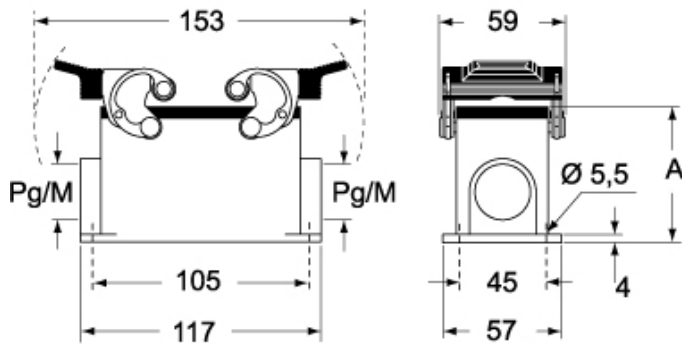

CMP CS/CP CMAP CS/CP - MMP CS/CP MMAP CS/CP

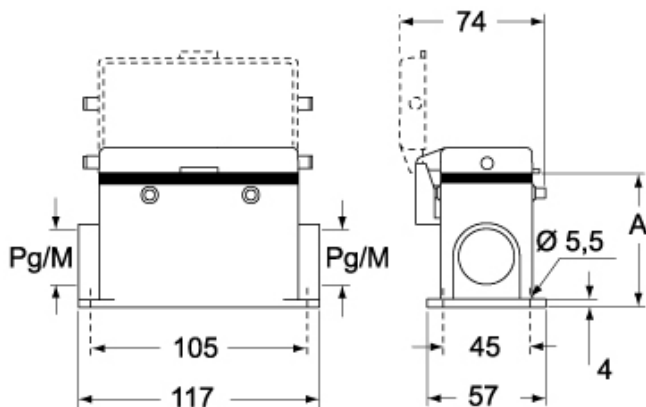

	A
CMP / MMP	63
CMAP / MMAP	77
CMP CS / MMP CS	63
CMAP CS / MMAP CS	77
CMP CP / MMP CP	63
CMAP CP / MMAP CP	77