

Part number

# CLI 16 LS



Bulkhead mounting housing, IL-BRID series, with 1 lever, size "77.27", with metal cover

Product description		Material properties	
<b>Product type</b>	Bulkhead mounting housing	<b>Other materials</b>	Lever: Polyamide (PA) and Stainless steel core Gasket NBR
<b>Series</b>	IL-BRID	<b>Colour</b>	RAL 7040 grey
<b>Closing type</b>	With 1 lever	<b>RoHs conformity</b>	Compliant
<b>Size</b>	Size 77.27	<b>China RoHs - EFUP</b>	E
<b>Specification</b>	With metal cover	<b>REACH SVHC substances</b>	No
Technical data		General ordering information	
<b>IP degree of protection</b>	IP65 / IP66 / IP69	<b>EAN13 code</b>	8015747286046
Further technical details		<b>eCl@ss 8.1</b>	27440202
<b>Weight</b>	0,50 g	<b>ETIM 7.0</b>	EC000437
<b>Operating temperature range (min, max)</b>	-40°C...+125°C	Packaging Information	
		<b>Packaging length</b>	475,00 mm
		<b>Packaging height</b>	220,00 mm
		<b>Packaging width</b>	200,00 mm
		<b>Packaging volume</b>	20,90 dm <sup>3</sup>
		<b>Packaging description</b>	Carton box
		<b>Packaging quantity</b>	20 Pcs
		<b>Packaging EAN code</b>	8015747087216
		<b>Sub-packaging description</b>	Plastic packaging
		<b>Sub-packaging quantity</b>	5 Pcs
		<b>Sub-packaging EAN barcode</b>	8015747087735

Part number

# CLI 16 LS



Catalogue drawings

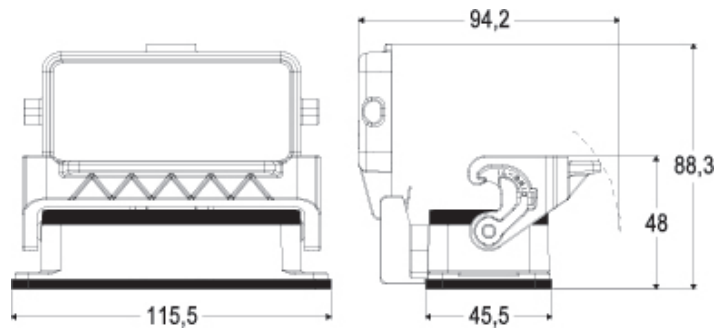

Catalogue drawings

